

LA-9961-T

Thesis

REPRODUCTION
COPY
IS-4 REPORT SECTION

Restore over Monday

Los Alamos National Laboratory is operated by the University of California for the United States Department of Energy under contract W-7405-ENG-36.

Make Up of High Explosive

Dinitro-1-Picrylbenzotriazole

LOS ALAMOS NATIONAL LABORATORY



3 9338 00310 0566

Los Alamos Los Alamos National Laboratory
Los Alamos, New Mexico 87545

This thesis was accepted by the Department of Chemical Engineering, University of New Mexico, Albuquerque, New Mexico, in partial fulfillment of the requirements for the degree of Master of Science in Chemical Engineering. It is the independent work of the author and has not been edited by the Technical Information staff.

DISCLAIMER

This report was prepared as an account of work sponsored by an agency of the United States Government. Neither the United States Government nor any agency thereof, nor any of their employees, makes any warranty, express or implied, or assumes any legal liability or responsibility for the accuracy, completeness, or usefulness of any information, apparatus, product, or process disclosed, or represents that its use would not infringe privately owned rights. Reference herein to any specific commercial product, process, or service by trade name, trademark, manufacturer, or otherwise, does not necessarily constitute or imply its endorsement, recommendation, or favoring by the United States Government or any agency thereof. The views and opinions of authors expressed herein do not necessarily state or reflect those of the United States Government or any agency thereof.

LA-9961-T
Thesis

UC-45
Issued: March 1984

Scale Up of High Explosive 5,7-Dinitro-1-Picrylbenzotriazole

John A. Sanchez

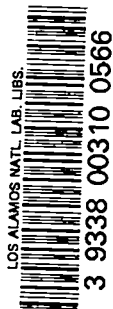

Los Alamos Los Alamos National Laboratory
Los Alamos, New Mexico 87545

TABLE OF CONTENTS

	Page
List of Figures	vi
List of Tables	vi
ABSTRACT	vii
Chapter 1 Introduction.	1
Chapter 2 Introduction to High Explosives Laboratory. . .	5
Laboratory Requirements	5
Laboratory Operations	8
Protective Clothing for Laboratory Operations .	10
Chapter 3 Preparation and Initial Testing	12
Initial Preparation	12
Flame Test.	13
Preliminary Impact Test	13
Elemental Analysis.	14
Preliminary Spark Sensitivity Test.	15
Differential Thermal Analysis	15
Chapter 4 Scale Up.	18
First Scale Up.	18
Drop-Weight Impact Test	18
Spark Sensitivity Test.	22
Further Scale Up.	22
Chapter 5 Plant Design and Manufacture.	25
Chapter 6 Performance	28
Detonation Velocity	28
Detonation Pressure	28

TABLE OF CONTENTS - Continued

	Page
Chapter 7 Experimental Work on BTX.	32
The Reaction.	32
Small Scale Study	34
Reflux Times.	36
Scale-Up Improvements	40
Scale-Up to Fifty Grams	44
Chapter 8 Economics	51
Chapter 9 Results and Discussion.	55
References.	59
Appendices.	60
Appendix A Standard Explosive Processing Specifications.	61
Appendix B Experimental Sensitivity Data . . .	77
Appendix C Experimental Analytical Data. . . .	81

LIST OF FIGURES

Figure		Page
1	Differential Thermal Analysis Sample Curve	16
2	Tool Holder Assembly Type 12 Tools	20
3	Drop-Weight Impact Machine	21
4	Preparation Description of BTX 10-Gram Scale	33
5	BTX-1 Drop-weight Impact Sensitivity	35
6	AESOP-170.	37
7	BTX-4 Impact Sensitivity	45
8	BTX-5 Impact Sensitivity	46
9	BTX-6 Impact Sensitivity 50-Gram Batch	50

LIST OF TABLES

Table		Page
1	Impact Sensitivity of Common Explosives.	23
2	Spark Sensitivity Values	24
3	Detonation Velocity of Selected HE	29
4	Detonation Pressure of Selected HE	30
5	Yield and Reflux Time Studies of 10-Gram Reaction.	39
6	Yield and Reaction Conditions 10-Gram Reaction	43
7	Yield of 10-Gram Reactions	47
8	Yield of 50-Gram Reactions	49
9	Economics of BTX Reaction Before Study	52
10	Economics of BTX Reaction After Study.	52
11	Cost of Common Explosives.	54

SCALE UP OF HIGH EXPLOSIVE
5,7-DINITRO-1-PICRYLBENZOTRIAZOLE

by

John A. Sanchez

ABSTRACT

Improvements were made to the reaction that produces 5,7- dinitro-1-picrylbenzotriazole (BTX). The reaction was first improved on a ten-gram scale that increased the yield nearly threefold. The reaction was then scaled up to a fifty-gram scale in which all the improvements of the ten-gram research proved beneficial. The improvement to the reaction involved reducing reflux and heating time, substitution of isopropanol for ethanol and sodium bicarbonate for sodium acetate, production of picryl chloride from picric acid, introduction of water to aid in solubility and analysis of BTX both chemically and for explosives sensitivity. The cost of producing BTX after improving the reaction is one-fifth of what it was before study. Thus the reaction was taken from a cumbersome, time consuming process for making BTX at a very poor yield to a reaction of reasonable yield, which is economically efficient and less time consuming with more readily available starting materials. The process is now ready for further work as the need for this special purpose explosive arises.

Several chapters of this study are devoted to describing high-explosives research. The description includes initial preparation, sensitivity testing, scale up, sensitivity and performance properties and plant design specifications.

CHAPTER 1

INTRODUCTION

An explosive is a solid, gas, or liquid substance that can be made to release tremendous heat and pressure through a rapid, self-sustaining exothermic decomposition. Although explosive processes can be classified as mechanical, nuclear, or chemical, chemical explosives are by far the best known, most widely used and will be the class discussed throughout this work.

Explosives are commonly divided into two main groups: (1) low or deflagrating explosives that function through burning processes characterized by rather slow, progressive reaction rates and pressure buildups that create a heaving action and (2) detonating explosives that are distinguished by rapid chemical reactions, causing very high pressures and brisance (shattering action) and extremely rapid rates of reaction, often characterized by detonation waves that frequently obtain a velocity in excess of 6100 m/s.

Low explosives are characterized by release of their energy through rapid burning, which can generally be controlled. Black powder was an early example of this type of explosive. Later additions to this type of explosive type were smokeless powders, which are used as propellants for both military and sporting arms. Many more have been added

since the introduction of modern rocket technology with its ever increasing need for specialized propellants.

High or detonating explosives can be further divided into primary (initiating) and secondary (noninitiating) explosives. Initiating or primary explosives can be detonated readily by heat, impact, or friction. They are generally used for the manufacture of initiating devices such as blasting caps, electric caps, percussion caps, and delay initiating devices. Included in the list of initiating or primary explosives are mercury fulminate, silver fulminate, and fulminate-chlorate mixtures, lead azide, silver azide diazodinitrophenol, and lead styphnate.

Secondary explosives include a number of organic or inorganic compounds that have been combined to produce desired properties of sensitivity, brisance, detonation velocity and stability. Common examples of this type of explosive are PETN, RDX, HMX, TNT, Teteryl, Composition B, and TATB. Secondary explosives are the type of explosive that will be discussed in this paper.

The safety standards which are used when working with high explosives have evolved through experience and communication in the field. Much activity in the high explosives field usually results during armed conflict. During and after the last world war many advances were made, in particular in the high explosives used in nuclear weapons. As a result a much more careful set of standards for working with high explosives has been generated. Working groups of

highly knowledgeable and experienced people review periodically all aspects of high explosives work from the very early research, to the transportation, to final disposal. One such working group is cited as a reference in the study.

This study has two major parts, the first of which is devoted to describing high explosives work in general and the second part which includes the experimental work performed in scaling up 5,7-dinitro-1-picrylbenzotriazole (BTX).

The familiarization with the high explosives research laboratory operations, safety and equipment requirements are described in Chapter 2. Included are the layout of the laboratory and the protective clothing needed by the researchers. The activities involved with the initial preparation of high explosives in the laboratory are presented in Chapter 3. A detailed test sequence which must be followed in order to ensure a safe and informative investigation of the high explosives sensitivity properties is also described.

In the course of studying an explosive, the need arises to produce larger quantities of explosive, which are required for gathering performance data as well as learning more about sensitivity. Chapter 4 contains the necessary procedures involved in scaling up to larger quantity batches. A description of the sensitivity tests which are necessary to scale up to larger research quantities is included.

In Chapter 5 the differences between plant design and manufacture of an explosive and a non-explosive are examined. Some of the special equipment specifications are described.

Performance properties like detonation velocity and pressure are important in any high explosive. The matching up of these properties with needed application for the high explosive is vital particularly in nuclear weapons applications. Chapter 6 describes these properties and includes a table of these parameters for some common explosives.

The scale up of BTX is important because of its stability at high temperatures and its moderate sensitivity. These properties make it useful in certain nuclear weapons applications. In order to learn more about these properties and performance properties more material is needed. The BTX production reaction, prior to this study, was a cumbersome, time consuming process resulting in very poor yield. As a consequence of this study, the time has been greatly reduced, the yield is much more reasonable and the reaction is economically efficient by use of more readily available starting materials. The experimental work on scale up of BTX, which is of major importance in this study, is presented in Chapter 7. The process scale up from three-gram to fifty-gram quantities while making improvements to the reaction that increased yield and reduced the total time of the reaction is also included in Chapter 7.

In Chapter 8 the economic advantages of the scaled up reaction are presented. A table of common explosives and their costs are listed as well as costs of BTX before and after scale up. Results and a discussion of the experimental work follow in Chapter 9.

CHAPTER 2

INTRODUCTION TO OPERATIONS IN A HIGH EXPLOSIVES LABORATORY

The ability to produce, evaluate and handle explosives requires specialized facilities, specific material handling procedures and a rigid, carefully constructed set of safety rules. These procedures, while cumbersome at times, are an absolute necessity and are outlined in this chapter. To characterize an explosive, the sensitivity of that explosive must be determined. Most of the sensitivity testing is done as early as possible in the development process in order to ensure safe operations and viability of scale up to a larger bench scale. This testing continues throughout the research and development of the explosive and on into production.

Laboratory Requirements

Operations involving high explosives (HE) in the laboratory are governed by certain general safety rules and procedures; additional rules for specific operations will be discussed later. In the latter case, special exception to the general safety rules must be stated clearly.

Much of the research and development is carried out in glassware in a chemical laboratory environment. Some of the special added equipment that is necessary for safety in an explosive research area are heat-sensitive automatic sprinkler systems, emergency showers and conductive concrete

floors. The walls are made of 30.5-cm thick reinforced concrete. Standard forced-draft hoods modified with sliding shields of 25.4-mm-thick bulletproof glass, stainless-steel-topped work tables, and laboratory sinks and floor drains are necessary in these laboratories. The floor drains and sink drains run into a sump outside the building for the collection of waste solids, particularly explosives. A cabinet warmed by steam pipes is located below the forced-draft hood. An explosion-proof refrigerator is also a necessary part of the explosives laboratory.

The utilities services that are provided for this type of laboratory are explosion-proof (EP) 120-volt single-phase and 208 volt EP three-phase electrical outlets; 15-psig steam; 55-psig compressed air; hot, cold, and distilled water; and natural gas outlets. Vacuum outlets are connected to a Whittington water-type vacuum pump housed outside the laboratory. Heat and ventilation are provided by a forced-air system controlled by individual room thermostats (LASL SOP 1961).

The use of open flames needs to be closely monitored. Generally, no open flames or smoking are to be permitted by anyone while exposed explosives, flammable solvents, or other conditions exist that would make these activities hazardous. "DANGER - NO SMOKING" signs must be posted in conspicuous places. It is the responsibility of the individual worker in his laboratory to determine when a hazard exists and take appropriate actions.

In working with explosives, the problem of accumulation of explosive materials in a confined space is always a concern. In a research laboratory, the same problem exists. A limit should be set on the amount of explosive depending on the nature of the explosives being handled. During the processing of explosives, only the minimum practical amount should be present in the laboratory. Excess over this amount should be stored elsewhere. During nonworking hours, only explosives "in process" and research samples should be left in the laboratory. In these cases a red "DANGER - EXPLOSIVES" sign must be displayed at the entrance to the laboratory.

A very important and hazardous operation is the drying of experimental explosives, particularly when elevated temperatures are required. This operation should always be done under the mildest conditions that will accomplish the drying. Circulating dry, warm air over a thinly spread layer of sample is probably the best way to dry most organic samples. A recommended procedure for drying all but the most hygroscopic materials is to dry the sample on the Buchner funnel on which it has been separated. A small stream of air pulled through the funnel supplies the required air circulation to dry the sample. Vacuum drying is a useful way of reducing the time and temperature required for drying small samples. Larger samples are usually dried more efficiently in forced-draft ovens.

Research samples (1 gram or less) may be dried in desiccators, vacuum ovens equipped with dual thermostatic controls, or in the steam-heated cabinet under the hoods in the laboratory (LASL SOP 1961). Only one sample at a time should be dried in a desiccator; several separate samples may be dried in an oven at one time. It is safer to remove the samples from an oven after the oven has been allowed to cool to room temperature, and this practice should be followed whenever practical (LASL SOP 1961).

Laboratory Operations

In general, the same basic safety practices hold true in an explosives chemical laboratory as in any chemical laboratory. Careful planning of experiments and of the action to be taken in a possible emergency will do much toward minimizing the consequences of unexpected hazards.

The general laboratory rules regarding cleanliness, orderliness, storage identification, movement of material, and equipment are necessary in any successful laboratory. The restriction on unattended or overnight experiments is of particular importance.

Some of the special rules regarding operation involving high explosives are worth noting in detail (LASL SOP 1961).

1. All operations involving explosives should be done on as small a scale as possible, consistent with good technique, while keeping in mind the intent of the experiment.

2. Whenever possible, these experiments should be carried out behind protective shields or barricades.
3. Whenever an experiment conducted behind a shield requires elevated temperatures, the heating device should be so mounted that it can be quickly lowered remotely from the reaction vessel without exposure to the operator. Temperature control of the bath should also be from the operator's side of the shield.
4. Dry materials should be stored and handled in plastic or rubber containers. The use of metal containers is forbidden, and glass may be used only when required by the nature of the material or the requirements of the experiment.
5. Disposal of explosives through a drain, while not forbidden, should be avoided as a matter of principle. Special care should be exercised to prevent entrance of compounds into the drain that may react with iron or rust to form sensitive salts (e.g., picrates and picric acid).
6. Grasp the container near the top while working with small quantities of explosives; even a separation of 20-50 mm between hand and the explosive can drastically reduce the damage that might result from unexpected detonation of a sample. Note that even a single layer of cloth, such as would

be provided by a laboratory coat or cotton work gloves, can significantly retard glass or plastic fragments from the explosion of a small quantity of explosive.

7. Any experiment involving a predictably high probability of an unwanted explosion or detonation of the sample should be discussed extensively with experienced explosives personnel and the appropriate safety personnel.
8. Only taped, coated, or plastic desiccators are to be used for explosives.
9. Many nitro compounds represent a significant health hazard. In working with new or experimental materials, care should be exercised at all times to avoid inhaling or ingesting the material, or allowing it to come in contact with the skin.

The above-numbered rules are important in laboratory operations involving high explosives.

Protective Clothing During Laboratory Operations

A variety of industrial safety equipment and clothing, such as safety glasses, face shields, conductive-sole safety shoes, gas masks, respirators, gloves, and aprons are available for use in a chemical research laboratory. The wearing of special protective equipment or clothing is required in many of the operations involving high explosives.

The minimum requirements for high-explosive operations carried out in a laboratory are listed below.

1. Safety glasses must be worn at all times by personnel.
2. Safety glasses must be worn by anyone entering the laboratory while an operation involving explosives is in progress.
3. Conductive-sole safety shoes must be worn by anyone working with explosives, flammable solvents or gases. Other safety equipment and special clothing should be considered depending on the explosive involved and the operation in progress.

CHAPTER 3

PREPARATION AND INITIAL TESTING OF NEW EXPLOSIVES

The purpose of this chapter is to define the general sequence of steps to be followed in the preparation and initial testing of new explosives. The term "new explosive" as used is to be interpreted to include any explosive whose sensitivity and thermal stability has not been measured and cannot be predicted with confidence on the basis of past work, and it further includes explosive or potentially explosive mixtures in addition to individual organic or inorganic compounds.

To attempt to specify the apparatus or procedure to be used in the preparation of a new explosive would not be wise. However, to control permissible quantities, define test procedures and to specify protective measures is prudent. The flame test and the preliminary impact test are designed to give an early indication of the hazards associated with the material.

Initial Preparation

The initial preparation must be scaled to give a theoretical yield of no more than 500 mg (LASL SOP 1961). If insufficient material is obtained for the completion of the flame test and the preliminary impact test, the preparation can be scaled up to a theoretical yield of 1 gram.

Flame Test

In this test the behavior of the explosive material is observed when a few crystals or a droplet of solvent-wetted explosive are heated on a spatula with a microflame. The test may be made on a sample still moist with solvent if due allowances in behavior are made for its presence. Vigorous, sustained burning until all the material is consumed is to be expected for a reasonably energetic explosive. Materials that appear to explode during the test, particularly without melting or burning, are to be regarded as fairly sensitive. Larger quantities of these material may be isolated only with extreme caution and the use of safety shields and protective clothing.

Preliminary Impact Test

A few milligrams of the material are placed on the clean surface of a steel plate or anvil. Residual solvent, if any, is allowed to evaporate, or is removed by a piece of filter paper in the case of a solid. The sample is struck by a sharp blow with a hammer. An audible reaction suggests that the material must be handled with great care, behind a safety shield if possible. Shock sensitivity may be quite high. In the absence of an audible reaction, the residue is examined for charring or other evidence of reaction. A second sharp blow on the consolidated residue of a solid sample will often result in a positive reaction.

The behavior of the highly shock-sensitive material discussed above indicates an explosive material in the

initiating explosive class, while an insensitive, inaudible result is fairly typical of explosives in the booster class.

The two tests described above are run by the originator of the sample, and the results must be considered before any further work is done on the material or before the material is turned over to someone else (LASL SOP 1961). A sample may be submitted for elemental analysis, if the material does nothing more than burn vigorously in the first test and no audible reaction occurs in the second. Otherwise, differential thermal analysis must be obtained.

It is recommended that the flame test and the preliminary impact test be repeated whenever a subsequent operation (such as recrystallization) has significantly altered the purity or nature of the product (LASL SOP 1961).

Other properties, such as melting point, IR spectrum, refractive index, and behavior in appropriate chemical tests also may be determined at this stage by the originator of the sample.

Elemental Analysis

Routine micro-elemental analyses on new explosive compounds are generally done very early in their development when sensitivity and stability data are still preliminary. If the analysis involves transferring the sample to another person, all information learned about the compound from the preliminary tests and any special instructions regarding

handling and storage must be attached. The quantity of the sample should not be more than 50 mg.

Preliminary Spark-Sensitivity Test

After the compound has been purified and a correct elemental analysis has been obtained, a 100-mg sample is submitted for a preliminary spark-sensitivity test. This test will determine whether or not the material is dangerously sensitive to electrostatic discharges.

Differential Thermal Analysis (DTA)

This test determines certain thermal properties of materials. The test uses a small quantity of material (20 mg) which is heated at a rate of 20°C/minute. Any spikes in the exotherm of the material are noted on the chart. A very sensitive high explosive will explode before the sample reaches the 350°C temperature to which the samples are heated. Depending on the sample submitted, it can be heated from room temperature to 500°C. The sensitivity to heating is an important parameter for scaling up to large size batches. A DTA curve for BTX is shown in Figure 1. Phase changes can be seen on the chart as well as decomposition and violent reaction of the explosives.

Observance of the permissible quantities of explosive produced and serious observation of the preliminary safety characterization results will ensure a safe investigation of

Figure 1. Differential Thermal Analysis
Sample Curve

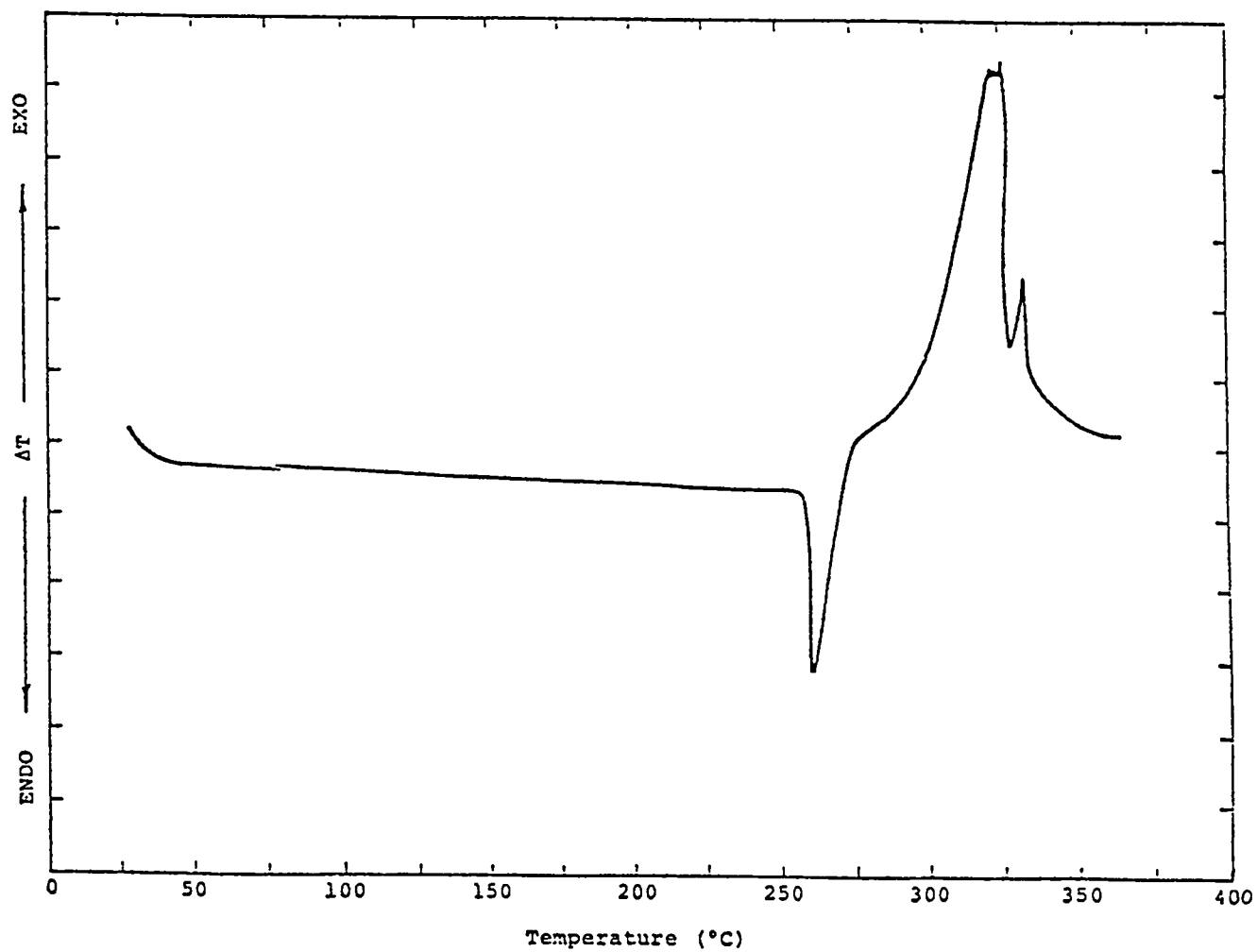

BTX DTA. 20°C/min heating rate.

a new explosive. An early indication of the hazards associated with the material are necessary if one wishes to scale up to larger quantity production.

CHAPTER 4

SCALE UP

Scale up of the reaction to produce larger quantities of the explosive product is done in stages as experience with the material increases. Sensitivity is the primary concern as well as overall safety in each additional scale up. When the scale up goes beyond 10 grams of material produced, written authorization must be obtained from experienced, knowledgeable explosives and safety personnel.

First Scale Up

The material may be scaled up to three grams or less for additional study after it has gone through the tests described above. Special attention must be given to materials that show sensitivity to the flame test, preliminary impact test, or preliminary spark sensitivity test when scaling to the larger quantity. Any question about sensitivity of the material must be considered before proceeding with the scale up to three grams. Once enough material has been prepared from the scale up, it should be submitted for complete impact and spark sensitivity tests.

Drop-weight Impact Test

A. Apparatus

From a safety point of view, the sensitivity of an explosive is probably the most important property

to determine. This property, however, is the most difficult to establish.

The Type 12 drop-weight impact test, is the most commonly used test to evaluate the sensitivity of a new explosive at some stage early in its development. The ERL machine, named for the Explosives Research Laboratory of the National Defense Research Committee, is shown schematically in Figures 2 and 3. The apparatus consists of a free-falling weight, tooling to hold the explosive sample, and a supporting frame. The 2.5 kg weight is made of hardened steel, and can be positioned at any desired height above the test sample to a maximum of 320 cm. An electromagnet retains the drop weight until released by the operator; it then impacts against the "striker" pin, which transmits the shock to the test sample. The explosive sample rests without restraint on a 25-mm-square piece of 5/0 grade flint sandpaper. The sandpaper in turn rests without restraint on an anvil 31-mm diameter by 31-mm long.

B. Instrumentation

A microphone records the audible sound; it is placed 0.864 m in a horizontal plane from the strike point. The signal from the microphone is transferred to a noisemeter that assigns a number between 0 and 10.

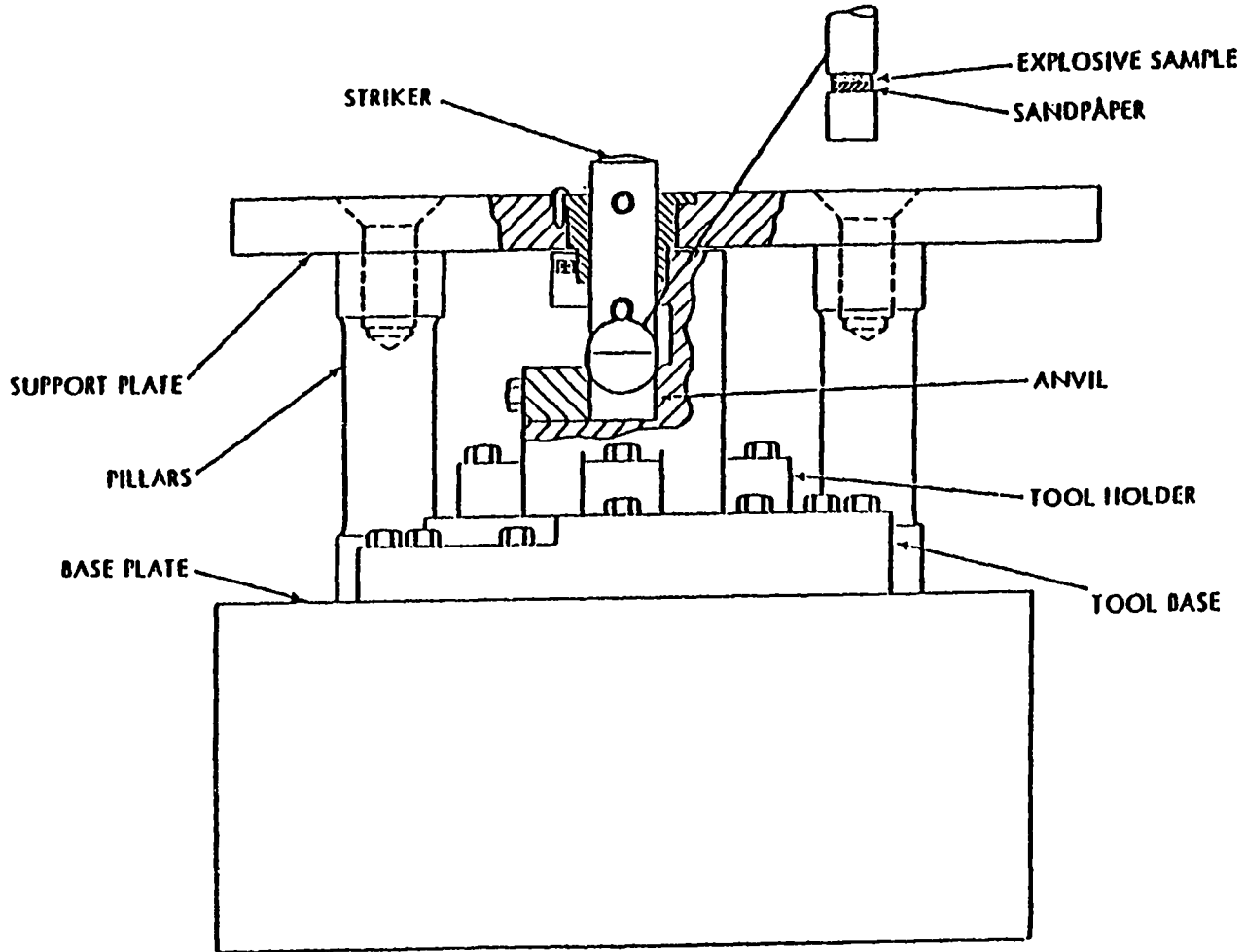
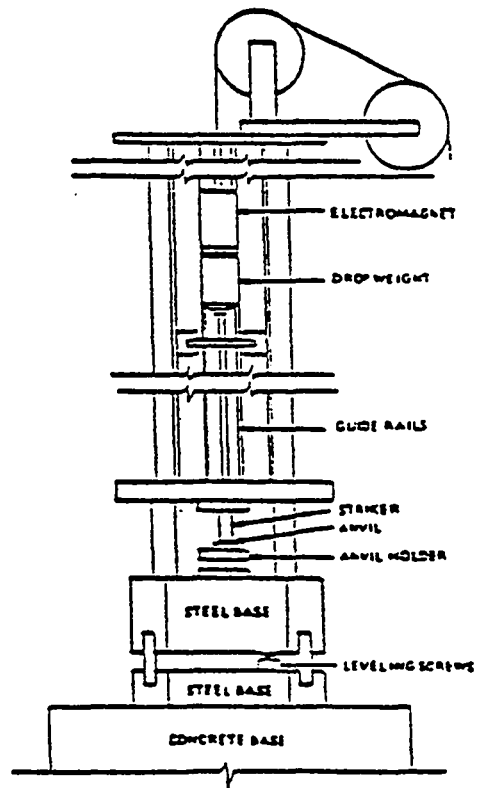

FIGURE 2.
TOOL HOLDER ASSEMBLY TYPE 12 TOOLS

FIGURE 3.

DROP WEIGHT IMPACT MACHINE, BASED ON
EXPLOSIVES RESEARCH LABORATORY MODEL
WITH TYPE 12 TOOLING.



C. Results

Using 40-mg samples, the impact test is done at different heights based on the readings obtained from the noisemeter. A twenty-five drop set is done and the fifty per cent point for a go/no go determines the height in centimeters for sensitivity. A list of common explosives and their impact sensitivities is given in Table 1 (Sensitivity 1966).

Spark-Sensitivity Test

The test used to obtain a more complete measure of the sensitivity of an explosive to electrostatic discharges is the spark-sensitivity test. In general, the test subjects an explosive sample to a single discharge from a condenser that has been charged to a high voltage. The energy of the discharge is varied, and the energy producing initiation of a sample in 50% of the trials is estimated by an up-and-down procedure. The sample size required to obtain a measure of electrostatic sensitivity is one gram. Table 2 shows the spark sensitivity value in joules of some common explosives.

Further Scale Up

A reaction to make an explosive may be scaled up to yield 10 grams of material if it has met the following conditions (LASL SOP 1961):

1. Fifty per cent points greater than 20 centimeters on Type 12 impact machine.

TABLE 1. IMPACT SENSITIVITY OF COMMON EXPLOSIVES

50% Points of Representative Explosives*

Lead Azide	9 cm
PETN	11 cm
RDX	23 cm
HMX	27 cm
Tetryl	47 cm
TNT	160 cm
DATB	320 cm

<u>*50% Point</u>	<u>Interpretation</u>
20 cm	Very sensitive, extreme caution indicated.
20-40 cm	Sensitive.
40-80 cm	Moderately sensitive, but probably safe for small-scale operations not involving harsh treatment.
80-100 cm	Moderately insensitive.
160-320 cm	Insensitive.
320 cm	Very insensitive.

TABLE 2. SPARK SENSITIVITY VALUES

<u>Sample</u>	<u>Joules</u>
PETN	0.19
RDX	0.21
HMX	0.23
TNT	0.46
Tetryl	0.54

The energy that can be built up on a human as static charge is about 0.015 joules.

2. Ignition energy greater than 0.1 joules in the spark sensitivity test.
3. Exhibits no exotherm below 100°C in the DTA-Pyrolysis Test.
4. Did not explode in the flame test.

This scale up will provide the necessary material to fully evaluate the sensitivity of the explosive material and the general nature of the chemical reaction. Some of the performance properties of the explosive can also be evaluated. These performance properties along with the sensitivity and safety of the production reaction will dictate whether additional development work is warranted. If further work is to be done, it must be outlined in advance and considered carefully. Authorization to scale up to larger quantity production must be obtained in writing after a detailed description of the proposed scale-up study has been presented.

CHAPTER 5

PLANT DESIGN AND MANUFACTURE

Safety aspects of design, construction and operation of a high-explosives plant are a prime consideration in any facility. Basically, HE plants are designed with many of the same components of other manufacturing plants. Unit operations take place in nearly the same fashion.

The actual physical layout of an HE plant is governed by AMCR-385-100 of the Ordnance Safety Manual. The compendium of data lists safe distance requirements for different work areas by the type of activity going on there. Also discussed are the basic construction requirements in regard to electrical wiring, light protection, utilities construction, fire protection, and several other aspects of physical layout and construction specifications. Another aspect discussed in this manual is the safe transportation and storage of HE, which relates directly to any HE manufacturing facility.

As mentioned, this AMCR (Army Material Command Regulation) generally governs the above-mentioned topics. However, the operators of most facilities have established their own set of regulations for their particular plant. It is rare to find these plant regulations less stringent than the AMCR regulations.

The operations of these HE facilities in terms of synthesis, mixing, preparation and packaging are governed by the historical handling of like materials and the direct experience with the material in the laboratory, scale-up states, and pilot-plant studies of the particular HE molding powder being made. A direct example of this is the production of an insensitive explosive triaminotrinitrobenzene (TATB) and the production of a much more sensitive explosive like cyclotetramethylenetetranitramine (HMX). The former, being less sensitive, allows more relaxed production procedures in, for instance, the filtering and drying stages than the HMX-based explosive.

Training and protection of employees in this type of production activity is especially important. The degree of protection is based on the material being worked, but generally follows Occupational Health and Safety Administration (OSHA) Rules. Training of an employee to work with explosives, on the other hand, is usually handed down from more experienced workers while making certain the safety rules are thoroughly understood. The mystique of working with HE must be addressed and overcome through experience and knowledge.

Equipment/plant design is based primarily on the material being produced. Some basic guidelines are common to most, if not all, HE production operations. Many of these requirements entail smooth surfaces, specifically shaped

welds, absence of cracks and crevices in equipment, no exposed threads, known gasket material, use of noncorrosive stainless steel, use of specifically designed plug valves free of any metal-to-metal pinch points, use of gravity feed where possible, and centrifugal pumps specially designed where gravity feed is not possible. These guidelines are presented in full detail in Appendix A. Other guidelines, based upon the operation in progress, are too numerous to list here.

CHAPTER 6

PERFORMANCE

Detonation Velocity

Detonation velocity is an important performance parameter in explosive characterization. The velocity with which a steady detonation travels through an explosive is measured by using a cylinder of explosive called a rate stick. The stick is detonated at one end and the progress of the detonation is measured at discrete points along the stick length. (Gibbs 1981). Typical detonation velocities of common explosives are listed in Table 3.

Detonation Pressure

The detonation pressure is important in any design involving explosives, because it drives inert materials and initiates other explosives. Although detonation pressure has been measured directly, the most commonly used values are from experiments in which they have been inferred from measured effects in other materials (Gibbs 1981). Table 4 lists the detonation pressures of common explosives on the inert materials used to make the measurements.

Other performance tests are done on the HE depending on the application. The most extensive testing is done on HE used for nuclear weapons. These tests will not be discussed here, but the reference (Gibbs 1981) contains complete descriptions.

TABLE 3. DETONATION VELOCITY OF SELECTED HES

Explosive	Density g/cm ³	Detonation Velocity (mm/μs)
Nitromethane Liquid	1.128	6.213
Amatex 20 20/20/40 RDX/TNT/AN	1.613	7.030
Baratol 76 24/76 TNT/Ba(NO ₃) ₂	2.619	4.874
Composition A 92/8 RDX/Wax	1.687	8.274
Composition B 36/63/1 TNT/RDX/Wax	1.700	7.859
Cyclotol 77/23 RDX/TNT	1.740	8.210
DESTEX 75/19/5/1 TNT/AL/Wax/- Carbon Black	1.696	6.816
OCTOL 77/23 HMX/TNT	1.814	8.481
PBX 9404 94/3/3 HMX/NC/CEF	1.846	8.773
PBX 9501 95/2.5/1.25/1.25 HMX/Estane/BDNPA/BDNPF	1.832	8.802
X-0219 90/10 TATB/Kel-F 800	1.915	7.627
X-0290 95/5 TATB/Kel-F 800	1.895	7.706
XTX-8003 80/20 PETN/Silicone Rubber	1.530	7.264

TABLE 4. DETONATION PRESSURE OF SELECTED HE

<u>Explosive*</u>	<u>Plate Material</u>	<u>Density</u> <u>g/cm</u>	<u>Detonation Pressure</u> <u>Gpa</u>
Composition B	Dural	1.713	29.35
Composition B	Brass	1.714	28.54
Cyclotol	Dural	1.742	31.24
Cyclotol	Plexiglas	1.200	12.36
Octol	Dural	1.809	33.84
PBX 9404	Dural	1.827	35.27
RDX	Dural	1.768	33.16
TNT	Dural	1.635	17.89-19.35

*Composition of explosives found in Table 3 Detonation of Velocity of Selected HES.

These sensitivity tests characterize the HE sufficiently to indicate its usefulness and safety.

CHAPTER 7

EXPERIMENTAL WORK ON BTX

The Reaction

Because 5-7-dinitro-1-picrylbenzotriazole (BTX) is stable at high temperatures, great interest has been expressed in its development. The reaction is a two-step process in which the intermediate 1-picrylbenzotriazole is made from picryl chloride and benzotriazole. The intermediate is then nitrated in a mixed acid medium to produce BTX. The reaction below outlines the reaction to be studied:

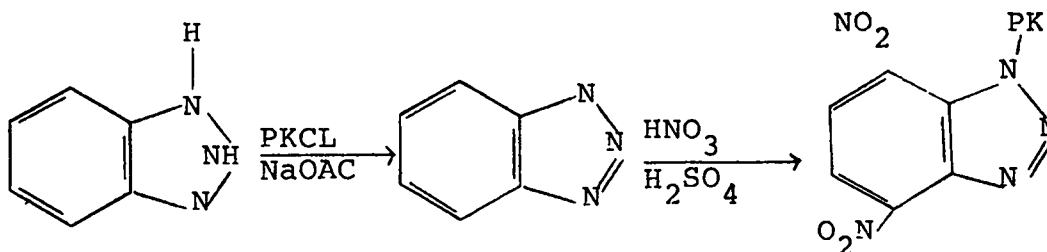

A parametric study of time/reactants/temperature would be needed to scale this reaction to larger quantity production. The 10 gram maximum production scale (Figure 4, Preparation Description of BTX 10-Gram Scale) will be used as a starting point. A parametric study will be done at this scale. Once the reaction is fairly well characterized, a larger scale preparation will be made to apply optimization

FIGURE 4

DESCRIPTION FOR PREPARATION OF BTX 10-GRAM SCALE

Benzotriazole (4.56 grams, 0.04 mole), picryl chloride (9.9 grams, 0.04 mole), sodium acetate (3.2 grams, 0.04 mole), and absolute ethanol (200 ml) are heated under reflux for five hours. The mixture is cooled in an ice bath to 10°C, then solid product is collected by filtration, washed repeatedly with water, and air dried to yield 5-8 grams of the intermediate 1-picrylbenzotriazole, mp 212°C.

Fuming nitric acid (90% HNO₃) (60 ml) is added to concentrated sulfuric acid (40 ml) with ice cooling. 1-Picrylbenzotriazole (5 grams) is added to the mixed acids at 5-10°C, and the resulting mixture is heated under reflux for 2 hours. The solution is cooled to room temperature and poured over ice (0.5 kg). The solid is collected by filtration, washed repeatedly with water, air dried, and recrystallized from acetone-ethanol. The yield is 4-7 grams of pure BTX, mp 263°C.

results of the 10-gram scale and to examine their effectiveness. The 10-gram scale reaction will be used for study because it is the largest scale explosive reaction that can be made without written authorization. This authorization can be obtained by writing an Abbreviated Experimental Standard Operating Procedure (AESOP), which must be approved by knowledgeable safety personnel. This AESOP will be written in the course of the study.

Small-Scale Study

BTX was prepared on a small scale as the starting point for study of the production reaction; the reaction was based on 0.04 mole quantities. The first preparation was done by a procedure outlined in the original synthesis by M. D. Coburn, Los Alamos Scientific Laboratory (1971). The product was tested according to the sensitivity tests outlined above. The flame test and preliminary impact test indicated an explosive of moderate sensitivity. The drop-weight impact sensitivity test gave a value of 50.2 cm on Type 12 tools (See Figure 5). This agreed well with previously tested samples of BTX. Two features of the reaction were immediately noted: The reflux times were excessive and a second crop of BTX crystals precipitated from the supernatant of the first white crop. The second crop of BTX crystals, while small in quantity (less than 10%), had a distinctive pink color. The melting point of pink BTX was recorded at 262°C, while white BTX melts at 263°C.

FIGURE 5

BTX-1 DROP-WEIGHT IMPACT SENSITIVITY

S A M P L E	Sensitivity		
	50% Height		σ
	log units	cm	log units
<u>Type 12</u>			
BTX-1	1.7010	50.2	0.049
<u>Type 12B</u>			
BTX-1	1.5593	36.2	0.089

Reflux Times

While waiting on approval to produce BTX on a 50-gram scale (WX-2 AESOP-170 Figure 6), a study of the reflux time was made on the 10-gram scale. The reflux time for the production of the intermediate (see preparation description, Figure 4) was reduced to one hour from the prescribed five hours. The resulting intermediate was produced in reasonable quantity to indicate the reaction to be essentially complete. The melting point was recorded at 212°C. This agreed exactly with the melting point of the intermediate 1-picrylbenzotriazole measured previously.

The reflux time of the reaction of 1-picrylbenzotriazole and the mixed acids (See Figure 4) was also adjusted. In the original preparation, a two-hour reflux was recommended. The reaction appeared to be complete at 48 minutes as evidenced by the NMR analysis. The rest of the preparation including the recrystallization was done according to the original procedure. This BTX did not differ from BTX produced earlier; however, the weight produced was somewhat less. Melting point and sensitivity were the same. Table 5 lists the three runs done on the 10-gram scale. Elemental analysis and NMR were done on this product to verify it and can be found in Appendix C.

After doing some parametric studies of the BTX reaction, and a limited economic study, it can be seen that the production of picryl chloride (the starting material in Figure 4) from picric acid would be cost-effective and

FIGURE 6.

WX-2 AESOP-170

Page 1

July 15, 1981

5,7-DINITRO-1-PICRYLBENZOTRIAZOLE (BTX)

I. PURPOSE OF EXPERIMENT

The procedure for the preparation of BTX, a thermally stable explosive, is being studied for the purpose of scaling up to larger quantities. The time and temperature parameters for the preparation will be looked at specifically for the scaling study.

II. OPERATING PROCEDURE

Benzotriazole (23.0 g., 0.2 moles), picryl chloride (49.69 g, 0.2 moles), sodium acetate (16.4 g, 0.2 moles), and absolute ethanol (0.5 to 1.0 liter) are heated under reflux for 1 to 5 hours. The mixture is cooled in an ice bath to 10°C - 25°C. The solid product is then collected by filtration, washed repeatedly with water, and air dried to yield 40-44 g of the intermediate 1-picrylbenzotriazole, m.p. 212°C.

Fuming nitric acid (90% HNO₃) (200 ml) is added to concentrated sulfuric acid (300 ml) with ice cooling. 1-Picrylbenzotriazole (40 g) is added to the mixed acids at 5-10°C, and the resulting mixture is heated under reflux for 0.75 to 2 hours. The solution is cooled to room temperature and poured over ice (2-3 kg). The solid is collected by filtration, washed repeatedly with water, air dried, and recrystallized from acetone-ethanol. The yield is 35-38 g of pure BTX, m.p. 263°C.

III. SENSITIVITY OF BTX

A) Impact

Type 12 - 35 cm
Type 12B - 33 cm

B. Spark

0.48 joules, 3-mil Foil.

IV. REACTIONS

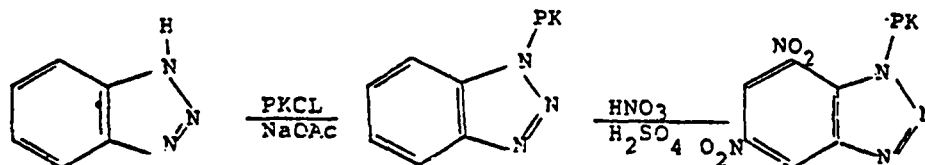

FIGURE 6. (Continued)

WX-2 AESOP-170
Page 2
July 15, 1981

V. SAFETY REQUIREMENTS

The reaction will be attended at all times by a WX-2 staff member in order to ensure safety of all parameters being studied.

APPROVED:

H. L. Flaugh
WX-2

R. W. Drake
WX-DO

Jack L. Blackwell
H-3

7-20-81
Date

22 July 1981
Date

August 26, 1981
Date

Distribution:

- H. L. Flaugh, WX-2
- T. E. Larson, WX-2
- R. W. Drake, WX-DO, MS 946
- L. A. Blackwell, H-3, MS 403
- K. Y. Lee, WX-2
- H. E. Cady, WX-2
- M. J. Urizar
- J. A. Sanchez
- WX-2 File

TABLE 5. YIELD AND REFLUX TIMES STUDIES OF 10-GRAM REACTION

<u>Reaction No.</u>	<u>Reflux Times</u>	<u>Yield (Grams)</u>	
		<u>1-Picrylbenzo triazole</u>	<u>BTX</u>
1	5 h Intermediate 2 h BTX/Mixed Acids	5.93	4.57
2	1 h Intermediate 48 min BTX/Mixed Acids	5.57	4.20
3	1 h Intermediate 48 min BTX/Mixed Acids	5.63	4.31

eliminate the need to obtain a source for picryl chloride. This improvement will be incorporated into the study of this reaction. Also, the substitution of isopropanol for ethanol will be examined.

Scale-Up Improvements

Improvements to make the BTX reaction easier to handle and more cost efficient are listed below.

1. Substitution of isopropanol for ethanol.
2. Reduction of the reflux times.
3. Substitution of sodium bicarbonate for sodium acetate.
4. Introduction of a small amount of water in intermediate production.
5. Preparation of picryl chloride from picric acid.
6. Maintenance of heating during nitration below reflux temperature.
7. Analysis of the second crop of BTX crystals that precipitate with their characteristic pink color.

These improvements will be tried on a 10-gram scale until a satisfactory product is produced. Taking these improvements one at a time the benefit derived will be discussed.

1. The substitution of isopropanol for ethanol will alleviate the licensing regulations necessary with the use of 100% ethanol, of particular concern during manufacture.

2. Reduction of the reflux times will make the reaction more efficient while minimizing the decomposition due to long-time elevated temperatures. Evidence of decomposition has been seen using NMR analysis of longtime heating.
3. The introduction of a small amount of water in the intermediate production will aid in the solubility of sodium bicarbonate.
4. Substitution of sodium bicarbonate for sodium acetate will lead to a more economical and stronger base. Whether the reaction will tolerate a stronger base will have to be examined.
5. The preparation of picryl chloride from picric acid will have to be done. No source was found for picryl chloride in large quantities. The picryl chloride reaction is known to be efficient, but will be evaluated.
6. The nitration stage in the formation of BTX during the last stage of the process calls for heating under reflux. Evidence indicates a decomposition of the reactant/products (mixed acids) may be taking place, thus adding additional contaminants to the reaction. How much lower than reflux temperature will be examined.
7. The presence of the second crop of crystals that are pink in color should be identified. If they are BTX crystals, the pink color must indicate

some contaminant; which might be eliminated by some of the suggested improvements.

The substitution of isopropanol for ethanol, the reduction of the reflux times to the times indicated by previous runs, the substitution of sodium bicarbonate for sodium acetate, the introduction of a small amount of water in the intermediate production, and keeping the temperature below reflux during nitration were tried on a 10-gram-scale reaction. The reflux times will also be studied by taking samples at specific time intervals to monitor conversion versus time. NMR was used to analyze the samples; charts can be found in Appendix C. Perhaps the most striking result of the changes listed above was that the yield of the reaction was doubled. (See Table 6)

All samples taken from the improved 10-gram scale reaction were examined by NMR. The samples were taken according to the following time intervals: During the intermediate production part of the reaction samples were taken at 45 minutes, 65 minutes, and a sample of the final product at 90 minutes of reflux. This was done in order to monitor the reflux time versus conversion to 1-picrylbenzotriazole of the starting products. The NMR analysis and the yield indicate a nearly complete reaction giving pure product at 90 minutes of reflux.

Samples were taken at 15-minute intervals during the conversion of 1-picrylbenzotriazole to 5,7-dinitropicrylbenzotriazole. The four samples taken at 15-minutes,

TABLE 6. REACTION CONDITIONS AND YIELD

Reaction Number	Reaction Conditions	Yield (grams)		
		1-picrybenzo triazole	BTX	Theoretical BTX
1	5 Hours Intermediate Reflux 2 Hours BTX/Mixed Acids	5.93	4.57	16.73
2	1 Hour Intermediate Reflux 48 Minutes BTX/Mixed Acids Reflux	5.57	4.20	16.73
3	1 Hour Intermediate Reflux 48 Minutes BTX/Mixed Acids Reflux	5.63	4.31	16.73
4	Material Handling, Economic Changes*	12.7	10.7	16.73

*Changes made were:

1. Substitution of isopropanol for ethanol in intermediate production stage.
2. Reduction of reflux time to 1-1/2 hours during intermediate production.
3. Substitution of sodium bicarbonate for sodium acetate with small amount H₂O added to aid solubility.
4. Reduction of reflux time in the production of BTX in the second stage of reaction.
5. Keeping temperature below reflux during nitration.

30-minutes, 45-minutes, and 60-minutes of heating just below reflux were examined by NMR, and there is some indication of decomposition of the BTX after 45-minutes of heating. Impact Sensitivity Test results are shown in Figure 7.

Another 10-gram batch was prepared using the improved procedure, but no samples were taken for analysis during the reaction. The reaction proceeded in approximately the same way as the previous run. The yield was down slightly, yielding 10.4 grams of recrystallized BTX. Impact sensitivity agreed well with the other BTX samples tested (Figure 8). Table 7 lists the 10-gram runs and quantities of material produced.

Fifty-Gram Scale Reaction

AESOP-170 was written and approved to produce BTX in a 50-gram batch (Figure 6). However, the improvements found beneficial on the 10-gram batch will be incorporated into this preparation. The physical arrangement of the reaction will be the same as for the 10-gram batch, although the glassware will be larger. The reaction was scaled directly from a 0.04-mole (10-gram batch) basis to a 0.2-mole basis (50-gram batch). The volume of solvents was kept in scale with the 0.04 mole to 0.2 mole scale up. The yield of the reaction was somewhat surprising because 52.4 grams of material was produced from an expected 50-gram scale reaction.

The nitration procedure of this BTX reaction should be changed to the use of white fuming nitric acid. Red fuming nitric acid was used interchangeably with white fuming (90%

FIGURE 7.

BIX-4 IMPACT SENSITIVITY

OFFICE MEMORANDUM

TO : John Sanchez, WX-2

DATE: 23 September 1981

FROM : M. J. Urizar

SUBJECT : Impact Sensitivity

SYMBOL : WX-2

S A M P L E	SENSITIVITY		STABILITY
	50% Height 100 units	C 100 units	ml/g/48 h at 120°C
<u>Type 12</u>			
PETN Std.	1.2892	19.5	0.134
BIX-4 (Raw material) 5, -7-dinitro-1-picrylbenzotriazole	1.7718	59.1	0.081
BIX-4 Recrystallized	1.7093	51.2	0.076

M. J. Urizar
M. J. Urizar

FIGURE 8.

BTX-5 IMPACT SENSITIVITY

OFFICE MEMORANDUM

TO : John Sanchez, WX-2

DATE: 9 October 1961

FROM : M. J. Urizer

SUBJECT : Impact Sensitivity

SYMBOL : WX-2

<u>S A M P L E</u>	<u>SENSITIVITY</u>		<u>STABILITY</u>
	<u>50% Height</u> <u>log units</u>	<u>g</u> <u>log units</u>	<u>ml/g/48 h</u> <u>at 120°C</u>
<u>Type 12</u>			
HMX Std.	1.5385	34.6	0.068
BTX-5	1.6968	49.7	0.088



M. J. Urizer

TABLE 7. REACTION CONDITIONS AND YIELD

Reaction No.	Reaction Conditions	Yield	
		1-picrybenzo triazo	BTX
1	5 h Intermediate Reflux 2 h BTX/Mixed Acids	5.93	4.57
2	1 h Intermediate Reflux 48 min BTX/Mixed Acids Reflux	5.57	4.20
3	1 h Intermediate Reflux 48 min BTX/Mixed Acids Reflux	5.63	4.31
4	Material Handling, Economic Changes*	12.7	10.7
5	Same as Reaction No. 4	---	10.4

*Changes made were:

1. Substitution of isopropanol for ethanol in intermediate production stage.
2. Reduction of reflux time during intermediate production to 1-1/2 hour.
3. Substitution of sodium bicarbonate for sodium acetate with small amount of H₂O added to aid solubility.
4. Reduction of reflux time in the production of BTX in the stage of reaction.
5. Keeping temperature below reflux during nitration.

nitric acid) with no real difference in yield, purity or reaction conditions. White fuming (90% nitric acid) is easier to use and to obtain.

A second 50-gram batch was produced in order to verify the yield from the first run, but the heating time during nitration was cut to 50 minutes. The quantity of recrystallized BTX produced was 51.9 grams. The supernatant liquid was cooled to encourage a second crop of crystals to appear. No secondary crop of pink crystals formed. The enhanced yield of the reaction, and thus the decrease in the nitric acid present, probably reduces solubility of BTX crystals in the supernatant liquor. Table 8 lists the amount produced from the 50-gram reactions. Impact sensitivity fell into the range established for BTX by this study and can be found in Figure 9.

TABLE 8. YIELD OF FIFTY-GRAM REACTIONS

<u>Reaction Number</u>	<u>Reaction Conditions</u>	<u>Yield (grams)</u>	
		<u>BTX</u>	<u>Theoretical</u>
1	Conditions of Improved 10-gram Reaction	52.4	83.64
2	Same as Reaction No. 1 However, heating during nitration was reduced to 50 minutes.	51.9	83.64

FIGURE 9
SENSITIVITY OF BTX-6 50-GRAM BATCH

<u>S A M P L E</u>	<u>SENSITIVITY</u>		
	<u>50 % Height</u>		<u>σ</u>
	<u>log units</u>	<u>cm</u>	<u>log units</u>
<u>Type 12</u>			
HMX Std.	1.4756	29.9	0.083
BTX-6	1.6718	48.1	0.041

CHAPTER 8

ECONOMICS

The economics of the BTX reaction, while not overly important because of the proposed use of this explosive in nuclear weapons, will be examined. This examination will serve to outline overall cost considerations and prove the worth of changes in the reaction.

The economic evaluation will examine the reaction from a bench-scale point of view in 10- and 50-gram batches and will be extrapolated to a 50-pound batch; the results are illustrated in Tables 9 and 10. It can be seen that, by producing the picryl chloride from picric acid, substituting isopropyl alcohol for ethanol, and sodium bicarbonate for sodium acetate, materials costs are down even though more materials are needed. These results are dramatic for the 50-pound production case. Improvement is also seen for the small-scale batches. The enhanced yield of the reaction because of the material substitutions and different operating conditions discussed earlier makes this reaction economically worthwhile.

Typical comparative costs of other explosives with similar properties and applications are not easily made because of the proposed special use of the BTX explosive. Costs of other explosives used in nuclear weapons range from eleven dollars a pound to a high of forty-five dollars a

TABLE 9. ECONOMICS OF BTX REACTION BEFORE IMPROVEMENTS

<u>Raw Materials</u>	<u>10-Gram Scale in Dollars</u>	<u>50-Gram Scale in Dollars</u>	<u>50-lb Scale in Dollars</u>
Benzotriazole	0.35	1.83	831.82
Picryl Chloride	2.39	11.98	5445.46
Sodium Acetate	0.01	0.05	22.73
Fuming Nitric Acid	0.38	1.90	35.66
Conc H ₂ SO ₄	0.14	0.70	22.07
Acetone	0.43	1.04	156.59
Ethanol 100%	<u>0.79</u>	<u>3.42</u>	<u>2373.20</u>
MATERIALS TOTAL	4.49	19.92	8887.53
DOLLARS/UNIT	\$.45/gram	\$.40/gram	\$177.75/lb

TABLE 10. ECONOMICS OF BTX REACTION AFTER IMPROVEMENTS

<u>Raw Materials</u>	<u>10-gram Scale in Dollars</u>	<u>50-gram Scale in Dollars</u>	<u>50-lb Scale in Dollars</u>
Benzotriazole	0.35	1.83	831.82
Picric Acid	1.36	6.80	215.09
Toluene	0.05	0.19	24.57
Thionyl Chloride	0.14	0.64	192.98
Dimethyl Formamide	0.001	0.005	2.57
Sodium Bicarbonate	0.01	0.05	1.87
Fuming Nitric Acid	0.38	1.90	35.66
Conc. H ₂ SO ₄	0.14	0.70	22.07
Acetone	0.43	1.04	156.59
Isopropanol	<u>0.15</u>	<u>0.64</u>	<u>291.91</u>
MATERIALS TOTAL	3.01	13.80	1775.13
DOLLARS/UNIT	\$.30/gram	\$.28 gram	\$35.50/lb

pound. It must be kept in mind that these explosives are much more expensive because of limited use in some cases and small quantity production in others. Nuclear weapon explosives also differ in the sensitivity and performance which are desired and may be in a more costly class than military or conventional explosives. A list of common explosives for military and nuclear weapon use can be found in Table 11. Each has a desirable application with the latter four more pertinent to nuclear weapons application. As further study and scale up of the BTX process is done, the expected price per pound should decrease. The extent of this decrease can not be determined, but will depend on innovation.

TABLE 11. COST OF COMMON EXPLOSIVES

<u>Explosive</u>	<u>Dollars/Pound*</u>
TNT	0.65
Composition B	3.50
PETN	2.08
RDX	6.00
HMX	9.72
PBX 9501	11.00
TATB	45.00

*Prices based on a minimum production of 40,000 pound.

CHAPTER 9

RESULTS AND DISCUSSION

The reaction for producing 5,7-dinitro-1-picrylbenzotriazole has been studied. The 10-gram scale reaction was looked at first while the setup for a 50-gram scale run was worked out. The experience gained from the 10-gram batches became invaluable because a run could be easily completed in the laboratory. The information gained on these small runs and applied directly to the scale up to 50 grams, proved successful.

The study of reflux times proved that the times necessary for these heatings could be substantially reduced. Reduction in these times to one fifth during intermediate production and one-half during nitration is economically valuable and also aids in production of a better product.

Several other changes were made to the reaction, which are significant to the increased yields obtained. The changes listed here are summarized from an earlier chapter.

1. Substitution of isopropanol for ethanol in the intermediate (1-picrylbenzotriazole) production stage.
2. Reduction of the reflux time to 1 to 1-1/2 hours during the intermediate production stage.

3. Substitution of sodium bicarbonate for sodium acetate.
4. Addition of a small amount of H₂O to aid with solubility of the sodium bicarbonate.
5. Reduction of temperature during reflux (heating). Temperature should be kept 5-10°C below reflux in order to discourage decomposition during the nitration process.
6. Heating time during nitration reduced to 1 hour.

These improvements were incorporated successfully into the 10-gram scale reaction and produced BTX at more than twice the quantity previously achieved. Sensitivity and analytical techniques indicated that the BTX produced was of good quality.

Two 50-gram batches were produced using the same improved procedure developed for the 10-gram batches. In each case, the quantity produced compared well with the 10-gram batches.

For large-scale production, a batch process is more reasonable because of the nature and characteristics of this HE. A less sensitive explosive would be a more reasonable candidate for a continuous or semi-continuous process.

The production of picryl chloride by chlorination of picric acid was another step that might be profitable. This process has been studied before for another application and should work well in the BTX process.

This study reduced materials costs significantly. While the number of raw materials needed for the improved process increased, the total cost of these materials is less than one-fifth the cost of the raw materials for the original process study. Even on a small scale, a savings in raw material costs is seen. These savings, while not as striking, represent a 66% savings on a 50-gram batch.

The original reaction to produce BTX resulted in a primary crop of white BTX crystals at a melting point of 263°. A second crop of pink BTX crystals formed after 10 to 15 minutes from the supernatant of the white crystals. The melting point of these pink crystals was 263°. Impact sensitivity and elemental analyses indicated that these pink crystals were BTX. The enhanced yield of the improved reaction reduced the solubility of the BTX crystals in the supernatant liquor and thus, this second crop phenomenon was not observed in the improved reaction, and thus was dropped from further studies.

A great deal of sensitivity testing was done on BTX. This testing will prove valuable as more development work is done on this reaction. Performance properties should be measured as more material is accumulated. These performance tests require larger amounts of material than the sensitivity tests already done.

This reaction is now ready to be scaled up to larger quantity batches. The work done on these small-scale batches will be useful in this task. The economic improvements

will no doubt carry on into large production. Interest and applicability of BTX will dictate whether more development on this explosive will be done.

LIST OF REFERENCES

Coburn, M. D., "Ten-Gram Scale Preparation of BTX," Los Alamos Scientific Laboratory, 1971.

Considine, D. M., Chemical and Process Technology Encyclopedia, New York, McGraw Hill Book, Co., 1974.

Gibbs, T. R., Popolato, A., Editors: Los Alamos Explosive Properties Data Book, Los Alamos Series on Dynamic Materials Properties, Berkeley: University of California Press, 1980.

Los Alamos Scientific Laboratory Standard Operating Procedures for Explosive Operations, SOP 1961, Group WX-2, Los Alamos National Laboratory, Los Alamos, NM, 1966

Manual of Sensitiveness Tests, The Technical Cooperation Program Working Group on Sensitivity, TTCP Panel O-2, 1966.

APPENDICES

APPENDIX A

EXPLOSIVE PROCESSING SPECIFICATIONS

STANDARD SPECIFICATION STATEMENT FOR
EXPLOSIVE MANUFACTURING EQUIPMENT (No. 1)

"This equipment is to be used in the manufacture of high energy explosives. Safety aspects of design and construction are a prime consideration. It is the intent of this specification to procure equipment that is free of any voids, pockets, cracks, or metal-to-metal pinch point where minute explosive crystals could possibly collect, or grow, and be subjected to mechanical pressures which could initiate a detonation. The explosive also tends to precipitate from a slurry and form a build-up on surfaces; hence rough surfaces, ledges, etc.; which aid in the build-up of coating (and make cleaning difficult) shall be avoided. While it is not feasible to cover in detail every design situation which may arise, the following examples should suffice to reflect the foregoing general requirements:

1. Lap joints with fillet welds are not permissible unless the lap is short enough for the penetration of the opposite fillet welds to fuse into one another (so there is no crevice between the lapped surface of the parent metals).
2. Butt welds on thin metals shall be full penetration and back welded. Butt welded heavy stock shall be beveled, or double beveled, and back welded. Enough beveling shall be provided so that welds from opposite side completely fuse with no voids or cracks.
3. Where butt welds terminate at an edge, except where the parent metal is too thin to allow it, the weld shall be run across the edge to the other side.
4. Welds on "wetted" surfaces shall be ground smooth."

STANDARD SPECIFICATION STATEMENT FOR
EXPLOSIVE MANUFACTURING EQUIPMENT (No. 2)
(For Air/Gas Moving Equipment)

"This equipment is to be used in the manufacture of high energy explosives. Safety aspects of design and construction are a prime consideration. It is the intent of this specification to procure equipment that is free of any voids, pockets, cracks, or metal-to-metal pinch point where minute explosive crystals could possibly collect, or grow, and be subjected to mechanical pressures which could initiate a detonation. While it is not feasible to cover in detail every design situation which may arise, the following examples should suffice to reflect the foregoing general notes:

1. Lap joints with fillet welds are not permissible unless the lap is short enough for the penetration of the opposite fillet welds to fuse into one another (so there is no crevice between the lapped surface of the parent metals).
2. Butt welds on thin metals shall be full penetration and back welded. Butt welded heavy stock shall be beveled, or double beveled, and back welded. Enough beveling shall be provided so that welds from opposite side completely fuse with no voids or cracks.
3. Where butt welds terminate at an edge, except where the parent metal is too thin to allow it, the weld shall be run across the edge to the other side.
4. Welds on surfaces exposed to gas stream shall be ground smooth.
5. All welds shall be sound, continuous, and full penetration having no pits, cracks, crevices, undercuts, blowholes, or voids of any sort. Slag and spatter are absolutely prohibited. See attached sketch for typical welded joint construction details.
6. Minute cracks and crevices normally present in standard equipment construction are not acceptable.
7. No threads (pipe, screw, etc.) shall be permitted exposed to the gas stream. Bolt heads are acceptable if self-locking nuts are used outside the gas stream.
8. Gasket material, if used, shall be 1/8" thick red rubber conforming to ASTM D1330.
9. See HDC Sketch No. 1844 for some typical weld joint details.

A. SCOPE

A-1 This Piping Standard prescribes general requirements for the fabrication erection and testing of piping systems, details of which are specified on HDC Piping Standards and Piping Diagrams prepared for the particular type of system under consideration. When stainless steel is involved, refer also to HDC Engineering Standard E-29, pages 101-102.

B. STANDARDS AND SPECIFICATIONS

B-1 Unless otherwise noted, reference to an American Standard, ASTM Specification, or HDC Standard is to be the latest revision of that Standard or Specification as approved by the body concerned.

B-2 Details not specified must comply with the applicable section of the USA B-31 Code for Pressure Piping, as noted in the particular HDC Standard under consideration.

C. PRESSURES AND TEMPERATURES

C-1 Unless otherwise specified, pressures referred to in all Piping Standards and Piping Diagrams are expressed in pounds per square inch above atmospheric pressure, i. e., psig, and all temperatures are expressed in degrees Fahrenheit.

D. MATERIALS

D-1 All materials used shall comply with all of the requirements of the specifications called for on the applicable HDC Piping Standard, drawing, or contract.

D-2 Contractor shall secure the approval of the designated HDC representative before making any substitutions.

E. PIPE THREADS

E-1 All threads on pipe, valves, fittings, etc., shall conform to American Standard for Taper Pipe Threads (USA B2.1) Threads shall be well-formed, smooth, and thoroughly clean.

1. SCOPE

This HDC Engineering Standard shall be used for all explosives process stainless steel piping at Plant B where the specified material is satisfactory for corrosion resistance. It must be used in conjunction with HDC Engineering Standard B-29, Pages 131-141, which prescribes general requirements for all piping systems, and with HDC Engineering Standard B-29, Pages 101-102, which applies to all stainless steel piping. Pipe sizes larger than 12" require special consideration.

2. PRESSURE-TEMPERATURE LIMITS

150 PSIG at 400°F.

3. PIPE

3.1 Inside Surface Finish

3.1.1 All piping conveying water-explosives slurries shall be annealed and pickled and weld bead reduced to a smooth surface finish.

3.1.2 Piping used for conveying acid-explosives slurries where coating is prevalent, such as dilution liquor (Chemical 522D) and Chemical 522, shall be fully annealed and pickled; the weld bead reduced to a smooth surface finish and have a roughness not to exceed a 15 RMS-mu. in. surface as described in ANSI Standard B46.1. The "Electro-Glo" electropolishing process applied to mill-finished pipe, is an acceptable finish.

3.2 1" through 12", Schedule 5S, welded seam, austenitic stainless steel pipe with plain ends - ASTM Designation A-312, Grade TP 304L - only one bend or turn is permitted between flanges.

4. FITTINGS

4.1 Inside Surface

4.1.1 All fittings conveying water-explosives slurries shall be annealed and pickled.

4.1.2 Fittings conveying acid-explosives slurries where coating is prevalent, such as dilution liquor and Chemical 522, shall be annealed and pickled and have a roughness not to exceed 15 RMS-mu. in. as described in ANSI Standard B46.1. The "Electro-Glo" electropolishing process applied to mill-finished pipe is an acceptable finish.

4.1.3 Screwed pipe connections are prohibited on all explosive process lines.

4.2 1" through 3", shop-fabricated pipe turns shall be used wherever possible instead of butt-welded purchased fittings. These pipe turns shall be made

This document is the property of Holston Defense Corporation and/or the United States Government and must not be used except in connection with HDC or the U. S. Government work. All rights of design or invention are reserved.

HOLSTON DEFENSE CORPORATION

ENGINEERING STANDARD

- | | <u>Type</u> | <u>Size</u> |
|-------|---|-------------|
| 6.1.4 | Plug, Straight-Way | 1/2"-6" |
| | <p>150 lb , type 316 ECL stainless steel body and plug, flanged ends, 150 lb , ANSI B16.4, TFE Sleeve-lined top and bottom caps 304 stainless steel, top and bottom cap bolt 304 stainless steel, top and bottom cap nut 304 stainless steel, TFE thrust washer, adjusting screws and nut 303 stainless steel, TFE bottom diaphragm, non-lubricated with device to ground plug to body. *Specify operating wrench to be included. This valve is to be modified with a FVC adjusting plunger and weep holes as shown on detail in Ref. 50.5. Shall be Duriron Co., Durco Type FT sleeveline valve.</p> | |
| 5.1.5 | Plug, Three-Way | 1/2"-6" |
| | <p>150 lb , type 316 ECL stainless steel body and plug, flanged ends, 150 lb , ANSI B16.5, TFE sleeve-lined, 304 stainless steel top cap and adjuster with 304 stainless steel bolts and 303 stainless steel nuts, non-lubricated with device to ground plug to body. *Specify operating wrench to be included. Shall be Duriron Co., Durco Type FG sleeve-lined valve, arrangement to be specified by Engineering Process piping specialist.</p> | |
| 6.1.6 | Plug, Three-Way | 1/2"-6" |
| | <p>150 lb , type 316 stainless steel body and plug, flanged ends, 150 lb , ANSI B16.5, TFE, sleeve and diaphragm, cover and thrust collar to be 304 stainless steel, type 304 adjusting screws, non-lubricated with device to ground plug to body. *Specify operating wrench to be included. Clearances between metal-to-metal contact points to be relieved as shown on detail in Reference 50.7. Shall be Xomox Corp. Tufline Fig. .037. (Specify plug arrangement.)</p> | |
| 6.2 | Diaphragm Valve, Two-Way | 1/2"-6" |
| | <p>150 lb , type 306 stainless steel polished body, handwheel-operated, non-rising stem with Tell-Tale travel stop, position indicator and travel stop bonnet, flanged ends, 150 lb , ANSI B16.5; the following diaphragms shall be used as indicated.</p> | |

<u>Diaphragm No.</u>	<u>Description</u>	<u>Service</u>
O-1	Teflon-Faced Neoprene	For services containing acids or solvents
McCannaplast 74	Ethylene-Propylene Copolymer (White)	For processes not containing acids or solvents
M-2	Kel-F-Solid	For special products
McCannaplast 36	Tripolyene (Black)	For service in weak acetic acid containing explosives

*Gear operators shall be used on 4" and 6" size valves.

This document is the property of Holston Defense Corporation and/or the United States Government and must not be used except in connection with HDC or the U. S. Government work. All rights of design or invention are reserved.

HOLSTON DEFENSE CORPORATION

12. BONDING

- 12.1 All new aboveground explosives process piping shall have bonding lugs welded to the pipe as shown in Ref. 50.12. These lugs will be used for bonding if field test indicates a need.
- 12.2 Explosives process piping systems shall be tested for electrical resistance and continuity. The maximum resistance from the piping system to ground is 10 ohms.

50. REFERENCES

- 50.1 HDCSTAN B-29-A, 501, "Pipe Bends, FDC Shop Made."
- 50.2 HDCSTAN B-29-A, 505, "Pipe Stub Ends, FDC Shop Made," and 511, "Modification to Durco Plug Valve, Type G4, Fig. G411."
- 50.3 HDCSTAN B-20-A, 512, "Durco, Fig. G-11, Sleeve-line Plug Valve, Detail of Spacer, Weep Holes."
- 50.4 HDCSTAN B-29-A, 516, "Tufline Fig. 067, Sleeved Valve, Detail of Metal-to-Metal Clearances, Spacer, Weep Holes."
- 50.5 HDCSTAN B-29-A, 521, "Durco Type FT, Sleeve-line Valve; Detail of PVC Adjusting Plunger, Weep Holes."
- 50.6 HDCSTAN B-29-A, 524, "Hills-McCanna Saunders, Diaphragm Valve, Detail of Weep Holes and Bonnet Lubrication."
- 50.7 HDCSTAN B-29-A, 528, "Tufline Fig. 037, Three-Way Plug Valve; Detail of Metal-to-Metal Clearances."
- 50.8 HDCSTAN B-29, 132, paragraph F, "Welding."
- 50.9 FDC Paint Standards, Section VIII.
- 50.10 HDCSTAN B-29, 136-138, paragraph J-2, "Hydrostatic Test."
- 50.11 HDCSTAN B-29, 140, paragraph J-5, "Leak Test."
- 50.12 HDCSTAN B-31-C-8, 505, "Electrostatic Bonding for Process Piping."
- 50.13 HDCSTAN B-31-C-8, 515, "Grounding Cable."

This document is the property of Holston Defense Corporation and/or the United States Government and must not be used except in connection with HDC or the U. S. Government work. All rights of design or invention are reserved.

HOLSTON DEFENSE CORPORATION

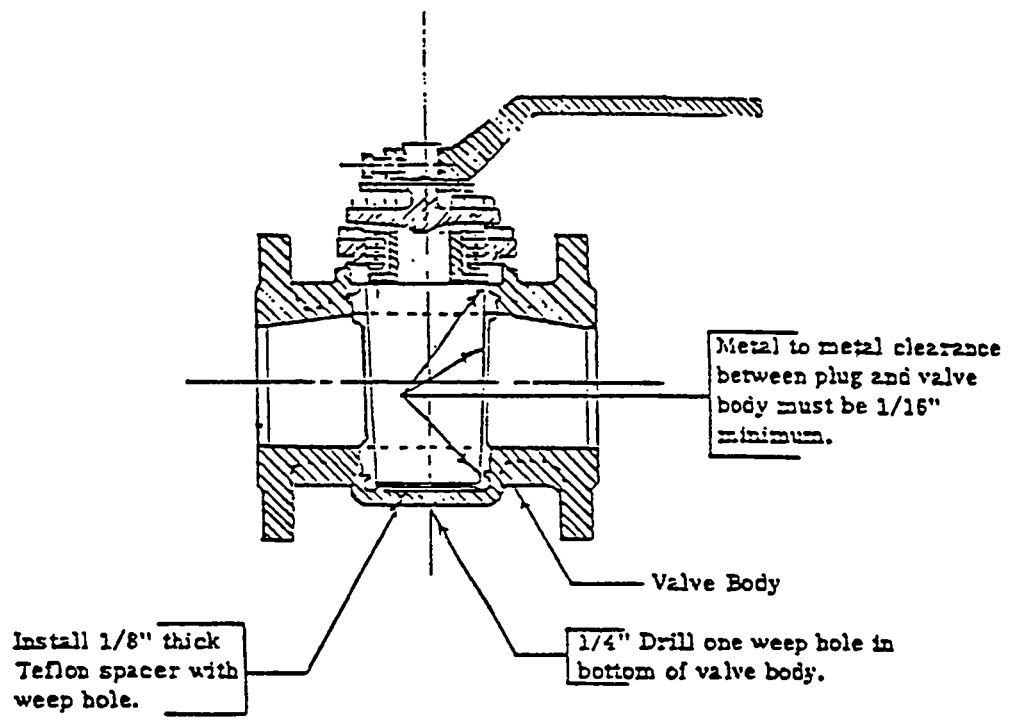

- Note: (1) These modifications, i.e. Teflon spacer, metal clearance, and weep hole, are required before this valve is installed.
- (2) This valve shall meet the electrical continuity test (described in Hdcstan B-29, Par. 6.1.1, Pages 501-508) before being placed in service.
- (3) All manual valve operators furnished by the valve vendor shall be permanently attached to the stem by a set screw or machine bolt.
- (4) Valve materials shall be as described in Hdcstan B-29, Pages 501-508, Par. 6.1.2.
- (5) This valve is referred to in Hdcstan B-29, Pages 501-508, Par. 6.1.2.1 and Ref. 50.2.1.

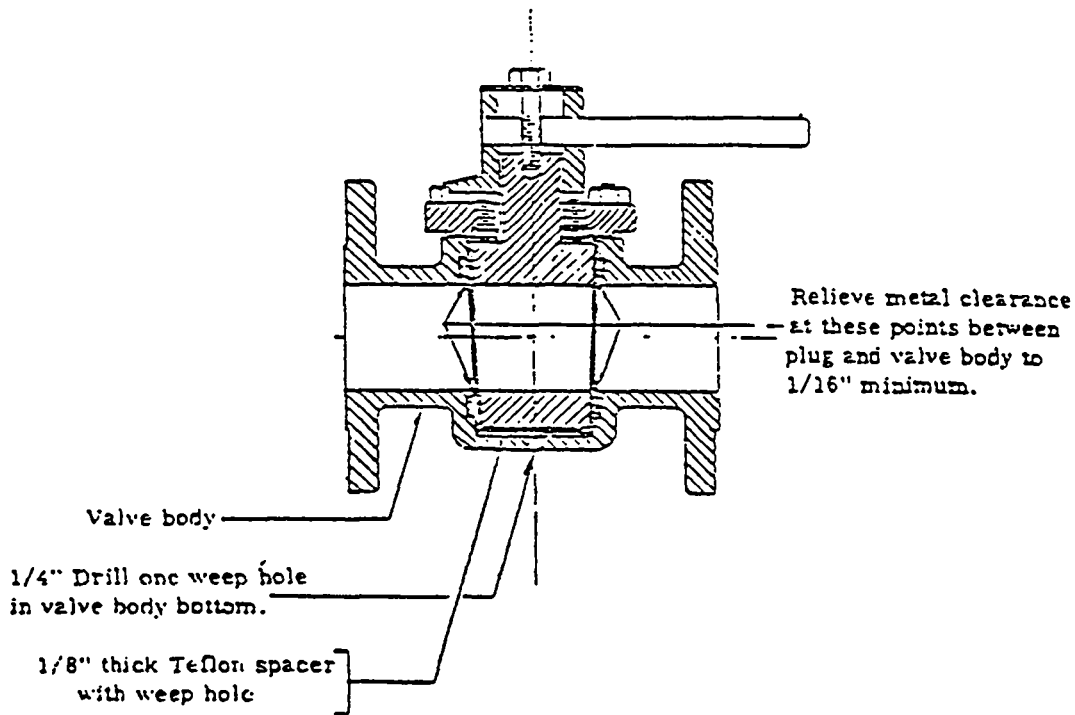

TUFLINE PLUG VALVE FIG. 067

- Notes:
- (1) These modifications, i.e. metal-to-metal clearances, Teflon spacer, and weep hole, are required before this valve is installed in an Explosives Process Piping System.
 - (2) This valve shall meet the electrical continuity test (described in Hdcstan B-29, Pages 501-508, Para. 6.1.1) before being placed in service.
 - (3) All manual valve operators furnished by the valve vendor shall be permanently attached to the stem by a set screw or machine bolt.
 - (4) Valve materials shall be as described in Hdcstan B-29, Pages 501-508, Para. 6.1.3.
 - (5) This valve is referred to in Hdcstan B-29, Pages 501-508, Para. 6.1.3, and Reference 50.4.

HOLSTON DEFENSE CORPORATION
ENGINEERING STANDARD

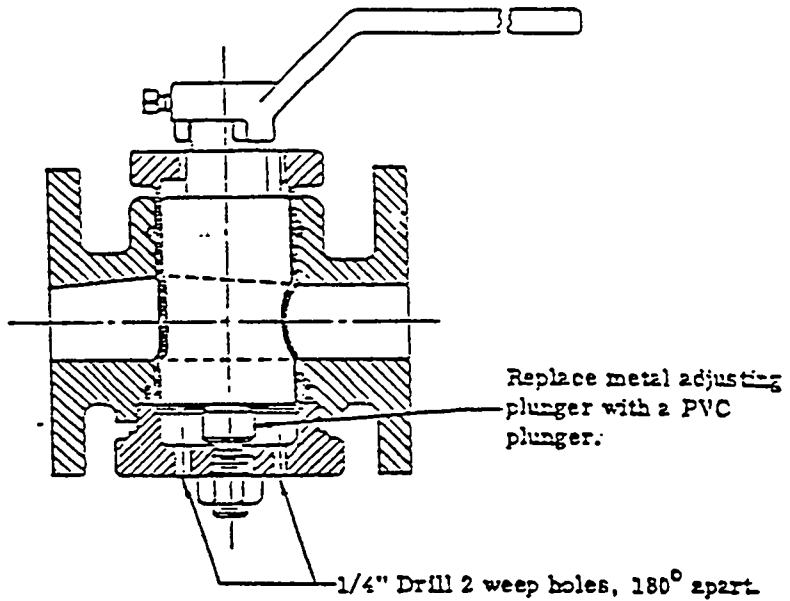

DURCO SLEEVELINE PLUG VALVE TYPE FT

- Notes:
- (1) These modifications, i.e. installation of a PVC adjusting plunger and weep holes, are required before this valve is installed in an Explosives Process Piping System.
 - (2) This valve shall meet the electrical continuity test (described in Edcstan B-29, Pages 501-508, Para. 6.1.1) before being placed in service.
 - (3) All manual valve operators furnished by the vendor shall be permanently attached to the stem by means of a set screw or machine bolt.
 - (4) Valve materials to be as described in Edcstan B-29, Pages 501-506, Para. 6.1.4.
 - (5) This valve is referred to in Edcstan B-29, Pages 501-508, Para. 6.1.4, and Ref. 50.5.

HOLSTON DEFENSE CORPORATION
ENGINEERING DEPARTMENT

Pack the inside of valve bonnet with Petrolatum - white vaseline, HDC Stock No. 564-6000-230

Install polyethylene shields. HDC Stock No. 359-7500-005. Shall be placed over the outside of the valve bonnet before fluid is circulated through the valve.

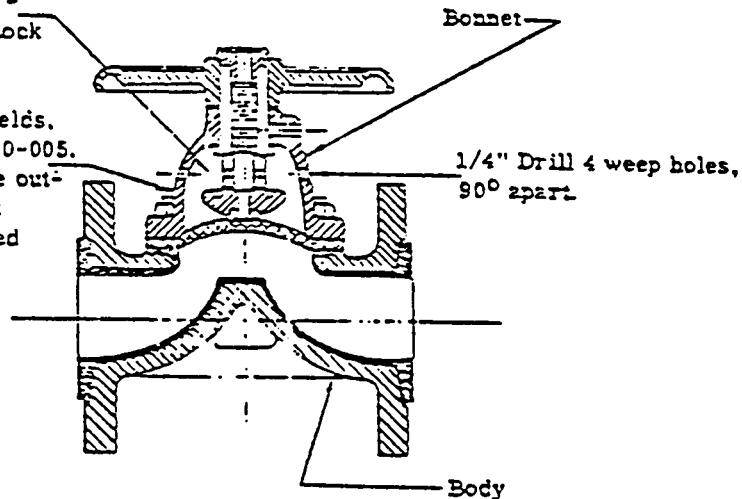

HILLS-McCANN SAUNDERS VALVE DIAPHRAGM TYPE

- Notes:
- (1) These modifications, i.e. weep holes, packing bonnet with vaseline, installing polyethylene shield, are required before this valve is installed in an Explosives Process Piping System.
 - (2) All manual valve operators furnished by the vendor shall be permanently attached to the stem by means of a set screw or machine screw.
 - (3) Valve materials shall be as described in Hdcstan E-29, Pages 501-506, Para. 6.2.
 - (4) This valve is referred to in Hdcstan E-29, Pages 501-506, Para. 6.2, and Ref. 50.6.

HOLSTON DEFENSE CORPORATION
ENGINEERING STANDARD

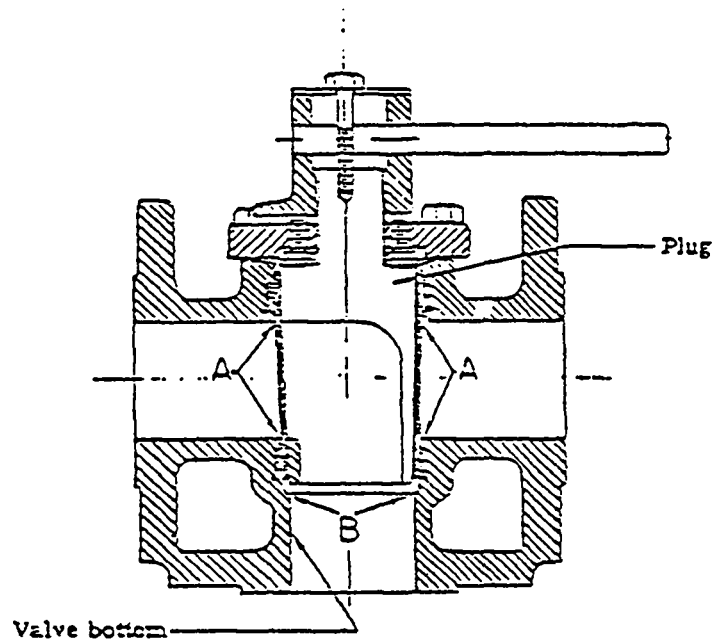

TUFLINE VALVE

FIG 037

(THREE-WAY)

- (1) Metal-to-metal clearances at points "A" to be relieved 1/16" minimum.
- (2) Metal-to-metal clearances at point "B" between bottom of plug and valve bottom to be 1/4" minimum.
- (3) The modifications described in notes (1) and (2) above are required before this valve is installed in an Explosives Process Piping System.
- (4) This valve shall meet the electrical continuity test (described in Hdcstan B-29, Pages 501-508, Para. 6.1.1) before being placed in service.
- (5) All valve materials shall be as described in Hdcstan B-29, Pages 501-508, Para. 6.1.6.
- (6) This valve is referred to in Hdcstan B-29, Pages 501-508, Para. 6.1.6, and Ref. 50.7.

UNION PACIFIC REFEREE CORPORATION

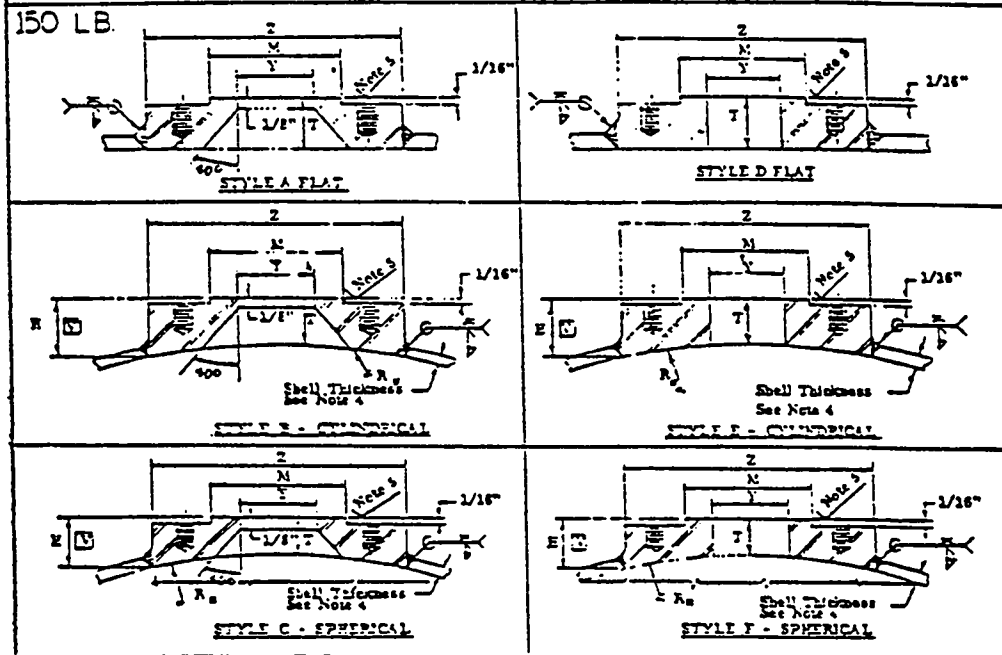

NPS and Bore	Z	M	T Minimum	BOLTING				Weight (Note 8)
				No. Studs	Stud Size	Stud Circle	Tap Depth	
1/2	3-1/2	1-3/8	1	4	1/2	2-3/8	3/4	2.7
3/4	3-7/8	1-11/16	1	4	1/2	2-3/4	3/4	3.2
1	4-1/4	2	1	4	1/2	3-1/8	3/4	3.7
1-1/2	5	2-7/8	1	4	1/2	3-7/8	3/4	5.0
2	6	3-5/8	1-1/4	4	5/8	4-3/4	13/16	8.9
2-1/2	7	4-1/8	1-3/4	4	5/8	5-1/2	15/16	11.9
3	7-1/2	5	1-1/4	4	5/8	6	1	15.1
4	8	6-3/16	1-1/4	8	5/8	7-1/2	15/16	18
5	10	7-5/16	1-3/8	8	3/4	8-1/2	1-1/8	24
6	11	8-1/2	1-3/8	8	3/4	9-1/2	1-1/8	26
8	13-1/2	10-3/8	1-3/8	8	3/4	11-3/4	1-1/8	36
10	16	12-3/4	1-5/8	12	7/8	14-1/4	1-3/8	62
12	18	16	1-5/8	12	7/8	17	1-3/8	70
14	21	16-1/4	1-3/4	12	1	18-3/4	1-1/2	96
16	23-1/2	18-1/2	1-3/4	16	1	21-1/4	1-1/2	115
18	25	21	2-1/8	16	1-1/8	22-3/4	1-11/16	142
20	27-1/2	25	2-1/4	20	1-1/8	25	1-11/16	185
24	32	27-1/4	2-3/8	20	1-1/4	27-1/2	1-7/8	226

- NOTES**
- These pad flanges are available from outside suppliers or may be fabricated at EDC shops.
 - This Standard describes pad flanges of steel (ASTM A285C, A315, A181) and stainless steel (ASTM A182, A240). These pad flanges match 150 lb ANSI standard flanges.
 - Studs shall be ASTM A193 Grade B7.
 - On styles C, E, & F, dimension H must be large enough to permit completion of full weld. Shell thickness must be shown.
 - Face finish shall be spiral or concentric serrated unless otherwise specified. Concentric serrations shall be approximately 25 serrations per inch with depth approximately 0.003" to 0.018". Spiral serrations shall be 20 to 40 serrations per inch with depth approximately 0.003" to 0.008".
 - Sample callout on drawing: 6" NPS pad flange per EDC Form B-14-1, 511, Style C, R-36", face 125 AARE, matl ASTM A-240.
 - Flange materials must be dye checked for laminations after welding.
 - Gross weight is pounds of one Style A carbon steel pad flange. Does not take into account weight lost by vessel when hole is cut for pad flange.
 - For dimension H see page 512. When requisitioning flanges to be purchased, do not specify dimension H.

H Variable to be specified in nozzle schedule of vessel drawing.

This document is the property of Holston Defense Corporation and/or the United States Government and must not be used except in connection with HDC or the U. S. Government work. All rights of design or invention are reserved.

HOLSTON DEFENSE CORPORATION

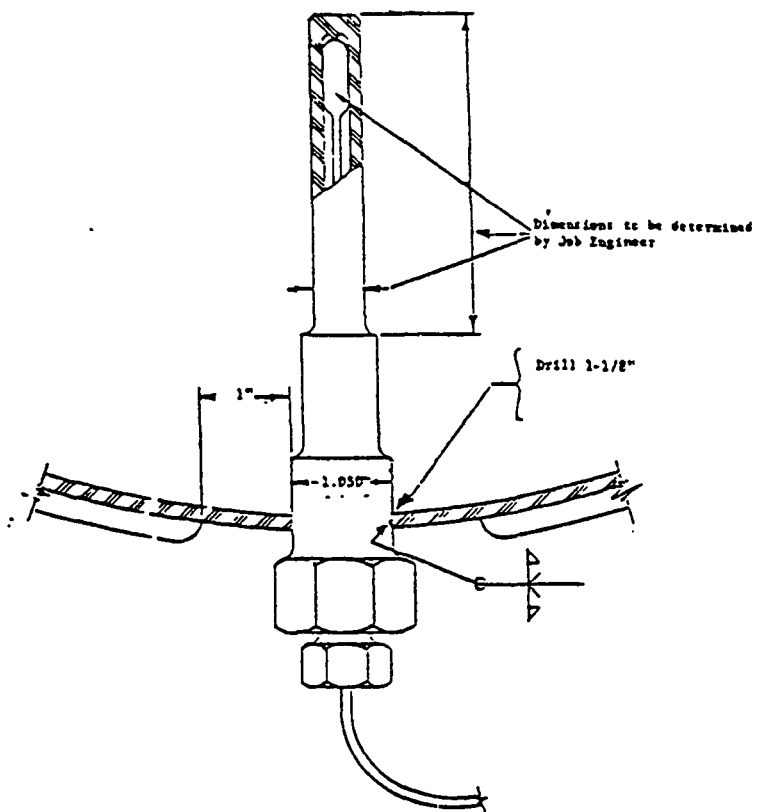

1. The material of construction of the thermowell must be compatible with the material of construction of the equipment (tank, pipe or other unit) with which it is to be used.
2. The thermocouple bulb must be correctly sized in length and diameter for use with the thermowell.
3. The location of the thermowell must be equally spaced between baffles in tank.
4. The location of the thermowell must be a minimum of 6 inches from the tip of the agitator blades.
5. If equipment with which the thermowell is used is insulated, the thermowell must have a 3-inch long outside extension.
6. If thermowell is to be installed in a unit in which inside welding is not possible, procedures approved by Design Engineering will be used.
7. If the thermowell is to be installed in an unagitated tank, the thermowell must be installed above the coils.
8. Thermowells will normally be purchased without external threads; any thermowell, externally prethreaded, must not be used in equipment in which explosives are processed without the removal of the threads.
9. Welding must comply with approved NDC Engineering Standards.

This document is the property of Holston Defense Corporation and/or the United States Government and must not be used except in connection with NDC or the U. S. Government work. All rights of design or invention are reserved.

HOLSTON DEFENSE CORPORATION

NW-3135 (Revised)

ENGINEERING STANDARD

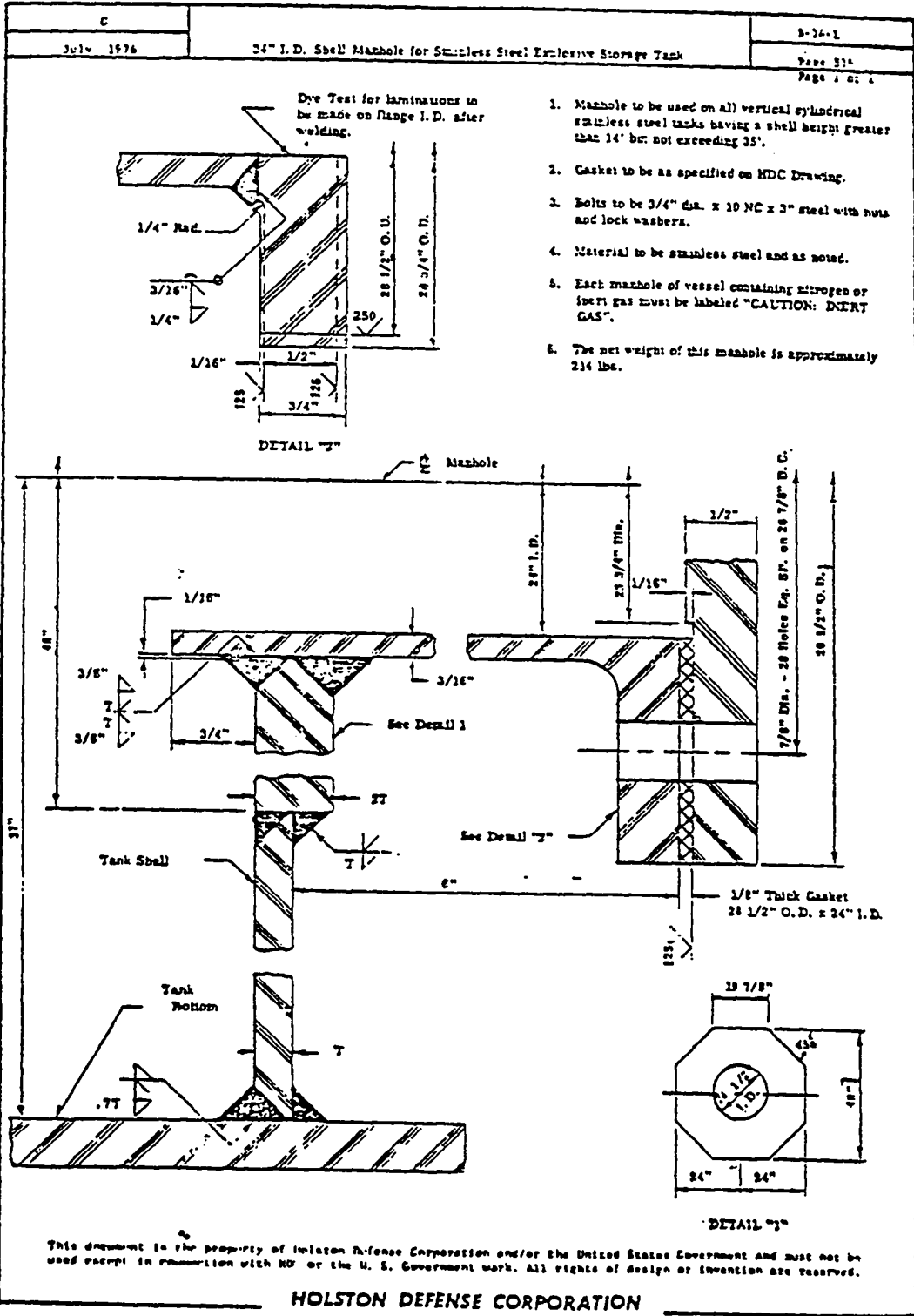

1. PURPOSE

This standard describes the minimum requirements for a pump that is safe for pumping explosives slurry solutions. This type of pump is intended for new and replacement explosives slurry installations in Explosives Production Department, Buildings "D" through "H" and B-Line applications from crude Chemical S22 receiving tanks through the final sludge and settling tanks.

2. INTRODUCTION

- 2.1 This specification covers centrifugal slurry pumps for use in the transfer of explosives. All wetted parts shall be stainless steel (See Paragraph 4.1 for description.) unless otherwise specified.
- 2.2 This specification differs from ordinary slurry pumps in that metal-to-metal pinch points are eliminated. In addition, areas where solids may accumulate (such as crevices) are to be avoided. Pipe threads, screw threads, or bolting may not contact the process fluid.
- 2.3 All information concerning operating data will be contained in the individual orders and shall constitute a part of this specification.

3. CONSTRUCTION

- 3.1 The pump shall be of the horizontal mounted type designed with a single end suction and a single vertical discharge. The impeller shall have clockwise rotation when viewed from the coupling end.
- 3.2 All parts of the pump which come in contact with the liquid must be free of pits.
- 3.3 Because the slurries handled are explosives, 1/16" (.062") clearance shall be provided between moving metal parts such as the impeller and casing. There must be no scraping or contact of metals while running and adjustment must be provided to maintain the clearance. Crevices formed by two ungasketed stationary parts must be at least 1/8" wide.
- 3.4 Where a shaft sleeve is used, the sleeve must extend through the stuffing gland. The impeller and shaft sleeve shall be a single unit, either cast as a single unit or fabricated by welding. The impeller and sleeve shall be a one-piece balanced unit which threads onto the pump shaft and extends through the packing gland so that there are no separate nuts, keys, pins, etc., exposed on the wetted end of the impeller. The impeller-sleeve

This document is the property of Holston Defense Corporation and/or the United States Government and must not be used except in connection with HDC or the U. S. Government work. All rights of design or invention are reserved.

HOLSTON DEFENSE CORPORATION
ENGINEERING STANDARD

APPENDIX B

EXPERIMENTAL SENSITIVITY DATA

OFFICE MEMORANDUM

TO : John Sanchez, WX-2

DATE: 7 August 1981

FROM : M. L. Clancy

SUBJECT : Impact Sensitivity

SYMBOL : WX-2

<u>S A M P L E</u>	<u>SENSITIVITY</u>		
	<u>50% Height</u>		<u>c</u>
	<u>log units</u>	<u>cm</u>	<u>log units</u>
<u>Type 12</u>			
BIX	1.7010	50.2	0.049
<u>Type 12B</u>			
BIX	1.5593	36.2	0.089

M. L. Clancy

M. L. Clancy

WX-2-F-43

OFFICE MEMORANDUM

TO : J. Sanchez, WX-2

DATE: 28 August 1981

FROM : M. J. Urizar

SUBJECT : Impact Sensitivity

SYMBOL : WX-2

<u>S A M P L E</u>	<u>SENSITIVITY</u>		
	<u>50% Height</u>		<u>c</u>
	<u>100 units</u>	<u>cm</u>	<u>100 units</u>
<u>Type 12</u>			
HMX Std.	1.5426	34.9	0.045
BTX -	1.7010	50.2	0.049 8/6/81
<u>Type 12B</u>			
HMX Std.	1.5801	38.0	0.056
BTX-S-3	1.6468	44.3	0.047
BTX-S-1	1.5593	36.2	0.089 8/6/81

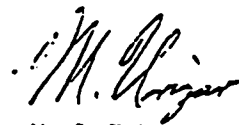
M. J. Urizar

WX-2-F-43

OFFICE MEMORANDUM

TO : John Sanchez, WX-2

DATE: 21 October 1981

FROM : M. J. Urizar

SUBJECT : Impact Sensitivity

SYMBOL : WX-2

<u>S A M P L E</u>	<u>SENSITIVITY</u>		
	<u>50% Height</u>		<u>G</u>
	<u>log units</u>	<u>cm</u>	<u>log units</u>
<u>Type 12</u>			
EMX Std.	1.4756	29.9	0.083
BIX-6	1.6718	48.1	0.041

M. J. Urizar

WX-2-F-43

APPENDIX C

EXPERIMENTAL ANALYTICAL DATA

Elemental Analysis of BTX Pgs. 82-88
NMR Monitor of BTX Reaction Pgs. 89-100

ELEMENTAL ANALYSIS RAW DATA

Program Code C073 Date 8/14/81
 Source J A SANCHEZ Anal. Requested CHNO
 Theory HIGHLY THERMALLY STABLE EXPLOSIVE BTXS-1
 Formula 5,7-DINITRO-1-PICRYLBENZOTRIAZOLE STRUCTURAL FORMULA
 M.P./B.P. MP 263°C
 Sample Dried _____ Dry Sample X
 Properties (hygroscopic, sensitivity)
12B 36cm

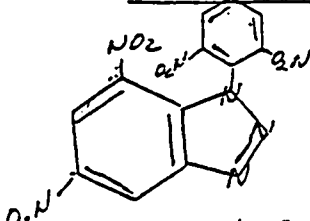
$$\begin{matrix} C = 24.3\% \\ N = 26.67\% \\ H = 1.95\% \\ N = 10 \\ O = 10 \\ C = 12 \\ H = 4 \\ MW 418.2 \end{matrix}$$

$C_{12}H_4N_8O_{10}$

DETERMINATION OF NITROGEN

Wt of Sample (mg) _____
 Vol_c (μl) _____
 Temp (°C) _____
 Pressure_c _____
 % N _____ Ave. _____

DETERMINATION OF CARBON AND HYDROGEN

Wt of Sample (mg) _____
 Wt H₂O _____
 Wt CO₂ _____
 % C _____ Ave. _____
 % H _____ Ave. _____

OTHER

REMARKS _____
 DATE COMPLETED _____ BY _____

OX-2-F-31

11F 9/2/81

Calibration runs Sta PYX 15507-127

z 1	z 2	z 3
24.07	24.93	24.19
31.60	32.84	32.13
1.03	1.15	1.18

Aug	z 1	z 2	% difference
	24.4	24.8	.4
	32.2	32.8	.6
	1.0	1.1	.1

JS Sample BTX5-1

z 1	z 2	z 3
N 25.29	26.53	26.48
C 33.16	35.64	36.42
H 1.15	1.11	1.17

z 1	z 2	z 3	% difference
24 25.30	25.9	26.6	.7
34.15	34.8	34.3	.5
1.08	1.1	.9	.2

PCAL# - 8
 ESTD
 REF % RTM: -0.20 CALIB RUNS 1
 % RTM: 5.00

CAL#	RT	AMT	AMT/HEIGHT
1R	3.54	2.4800E+01	9.995E-03
2R	3.94	3.2850E+01	3.5652E-03
3R	5.22	1.1400E+00	9.9650E-04

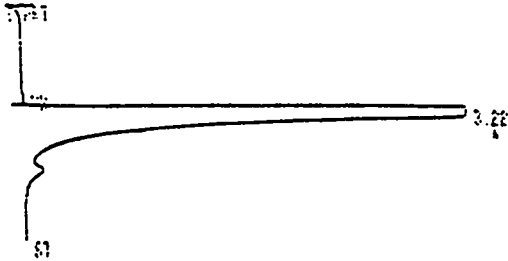

RUN # 11 SEP/02/81 09:19:18
 NO CALIB PEAKS FOUND

RT	HEIGHT	TYPE	AR/HT	HEIGHT%
3.22	46766	FB	6.243	100.000

TOTAL HGHT= 46766
 MUL FACTOR= 1.0000E+00

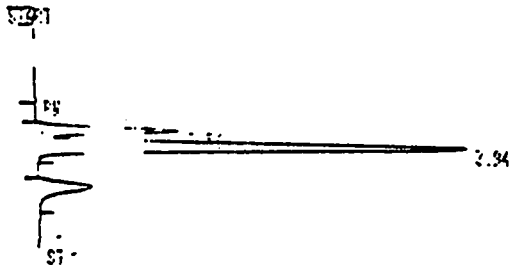

RUN # 12 SEP/02/81 09:26:34

RT	HEIGHT	TYPE	CAL#	AMOUNT
3.51	2675	EV	1R	21.821
3.94	8843	VB	2R	31.809
5.14	1642	FB	3R	1.038

TOTAL HGHT= 12560
 MUL FACTOR= 1.0000E+00

Cal 2

PCAL# 2
 ESTD
 REF % RTM: -0.20 CALIB RUNS 2
 % RTM: 5.00

CAL#	RT	AMT	AMT/HEIGHT
1R	3.53	2.4800E+01	9.1346E-03
2R	3.97	3.2850E+01	3.6357E-03
3R	5.20	1.1400E+00	1.0453E-03

RUN # 12 SEP/02/81 09:26:34

RT	HEIGHT	TYPE	AR/HT	HEIGHT%
3.51	2675	EV	0.200	21.259
3.94	8843	VB	0.241	70.460
5.14	1642	FB	0.339	8.281

TOTAL HGHT= 12563
 MUL FACTOR= 1.0000E+00



RUN # 13 SEP/02/81 09:41:02

RT	HEIGHT	TYPE	CAL#	AMOUNT
3.33	44389	FB	1R	484.750

TOTAL HGHT= 44389
 MUL FACTOR= 1.0000E+00

3

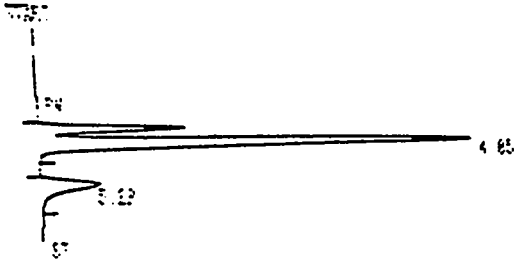

RUN # 14 SEP/02/01 09:56:03

ESTD RT	HEIGHT	TYPE	CAL#	AMOUNT
3.61	2720	BY	1R	24.878
4.05	9034	VB	2R	32.845
5.29	1109	BB	3R	1.159

TOTAL HGHT= 12873
MUL FACTOR= 1.0000E+00



RUN # 15 SEP/02/01 10:24:11
NO RUN PEAKS STORED

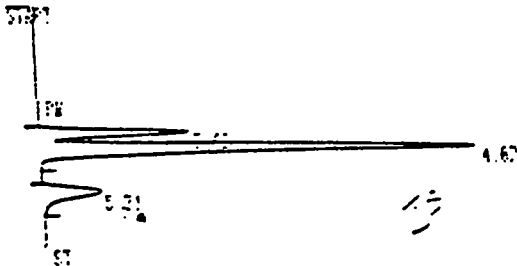

RUN # 16 SEP/02/01 10:31:10

ESTD RT	HEIGHT	TYPE	CAL#	AMOUNT
3.62	2769	BY	1R	25.294
4.67	9123	VB	2R	33.169
5.31	1103	BB	3R	1.153

TOTAL HGHT= 12995
MUL FACTOR= 1.0000E+00



RUN # 17 SEP/02/01 10:39:10
NO CALIB PEAKS FOUND

HEIGHT%	RT	HEIGHT	TYPE	AR/HT	HEIGHT%
100.000	3.25	45405	PB	0.246	100.000

TOTAL HGHT= 45405
MUL FACTOR= 1.0000E+00

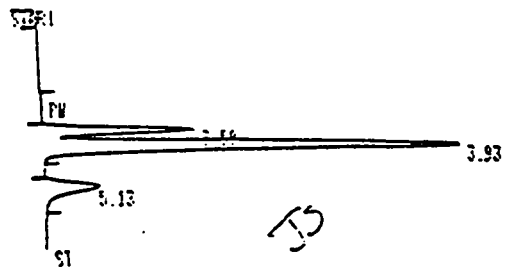

RUN # 18 SEP/02/81 10:45:45

ESTD	RT	HEIGHT	TYPE	CAL#	AMOUNT
	3.50	2905	BV	1R	26.537
	3.93	9803	VB	2R	35.641
	5.13	1066	BB	3R	1.114

TOTAL HGHT= 13774
MUL FACTOR= 1.0000E+00

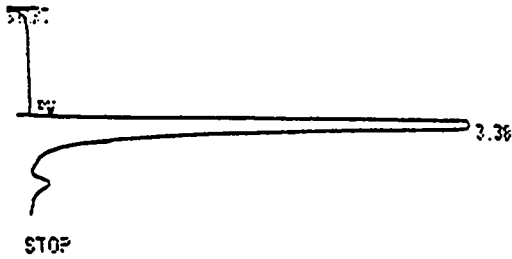

RUN # 20 SEP/02/81 11:01:35

ESTD	RT	HEIGHT	TYPE	CAL#	AMOUNT
	3.66	2921	PV	1R	22.482
	4.10	10219	VB	2R	32.422
	5.36	1120	PB	3R	1.171

TOTAL HGHT= 14868
MUL FACTOR= 1.0000E+00

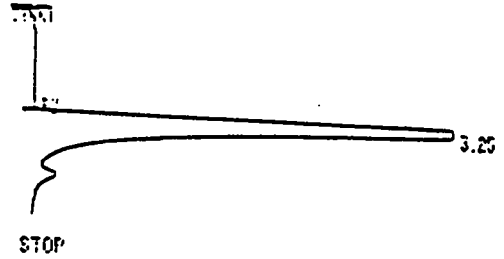

RUN # 19 SEP/02/81 10:55:12

ESTD	RT	HEIGHT	TYPE	CAL#	AMOUNT
	3.38	46009	PB	1R	420.288

TOTAL HGHT= 46009
MUL FACTOR= 1.0000E+00

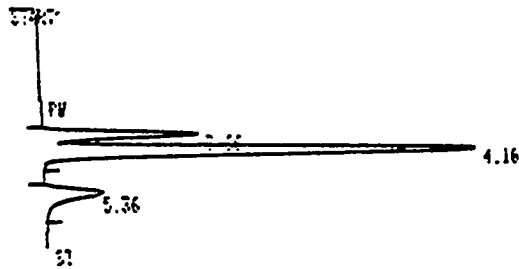

RUN # 21 SEP/02/81 11:10:15
NO CALIB PEAKS FOUND

HEIGHT%	RT	HEIGHT	TYPE	AR/HT	HEIGHT%
	3.25	47129	PB	0.242	100.000

TOTAL HGHT= 47129
MUL FACTOR= 1.0000E+00

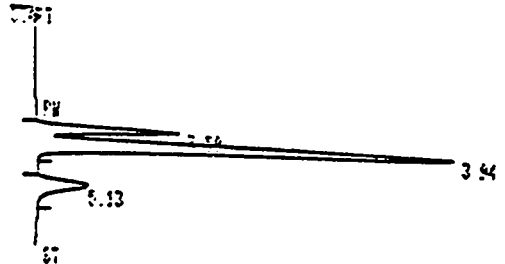

7

RUN # 22 SEP/02/81 11:16:41

ESTD	RT	HEIGHT	TYPE	CAL#	AMOUNT
	3.50	2770	PV	1R	25.363
	3.94	9395	VB	2R	34.158
	5.13	1037	PB	3R	1.084

TOTAL HGHT= 13202
MUL FACTOR= 1.0000E+00

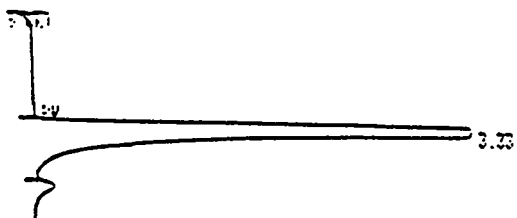

STOP

RUN # 23 SEP/02/81 11:30:35
NO CALIB PEAKS FOUND

HEIGHT%	RT	HEIGHT	TYPE	AR/HT	HEIGHT%
	3.33	44866	PB	0.243	100.000

TOTAL HGHT= 44866
MUL FACTOR= 1.0000E+00

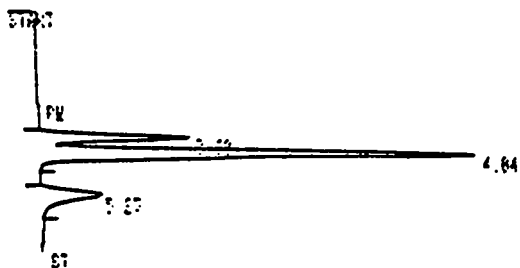

RUN # 24 SEP/02/81 11:36:57

ESTD	RT	HEIGHT	TYPE	CAL#	AMOUNT
	3.60	2780	VB	1R	25.395
	4.04	9221	VB	2R	33.525
	5.27	1143	PB	3R	1.195

TOTAL HGHT= 13144
MUL FACTOR= 1.0000E+00

SCALE: 0

ESTD
REF % RTW: -0.20 CALIB RUNS 3
% RTW: 5.00

CAL#	RT	AMT	AMT/HEIGHT
1R	3.56	2.4800E+01	9.6535E-03
2R	4.00	3.2860E+01	3.6117E-03
3R	5.22	1.1400E+00	1.0253E-03



RUN # 25 SEP/02/81 13:29:07
NO CALIB PEAKS FOUND

HEIGHT%	RT	HEIGHT	TYPE	AR/HT	HEIGHT%
	3.26	26324	PB	0.261	100.000

TOTAL HGHT= 26324
MUL FACTOR= 1.0000E+00

500 9

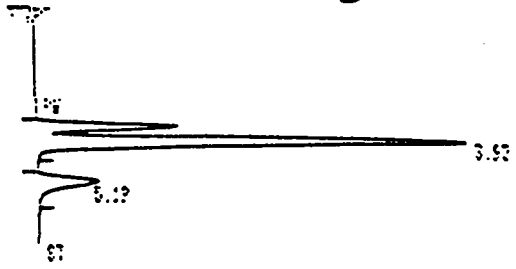

RUN # 26 SEP/02/81 13:47:02

ESTD	RT	HEIGHT	TYPE	CAL#	AMOUNT
	3.50	2670	PV	1R	24.199
	3.93	8398	VB	2R	32.137
	5.12	1147	PB	3R	1.181

TOTAL HGHT= 12715
MUL FACTOR= 1.0000E+00

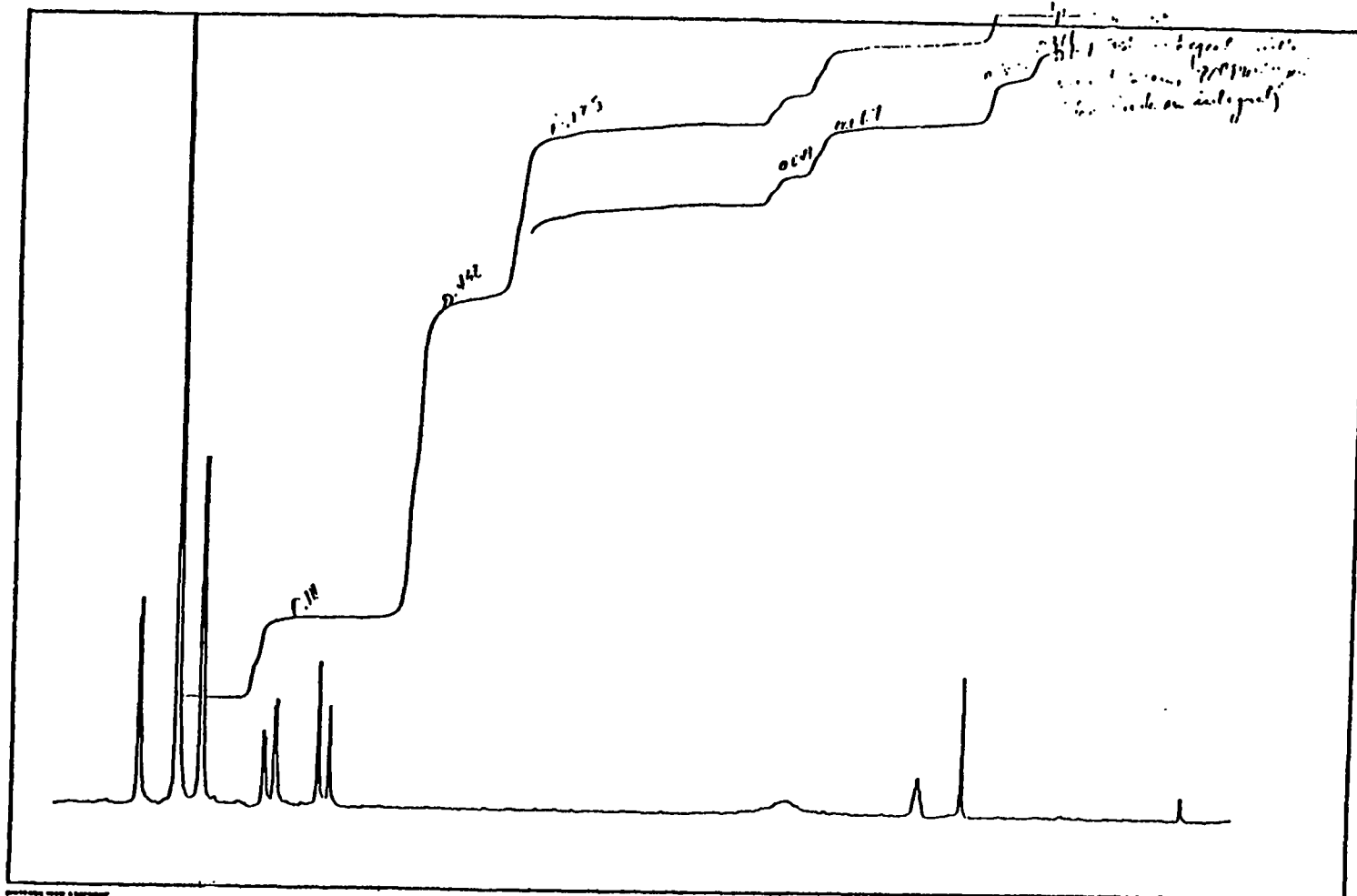

Figure C-1. First Run NMR BTX

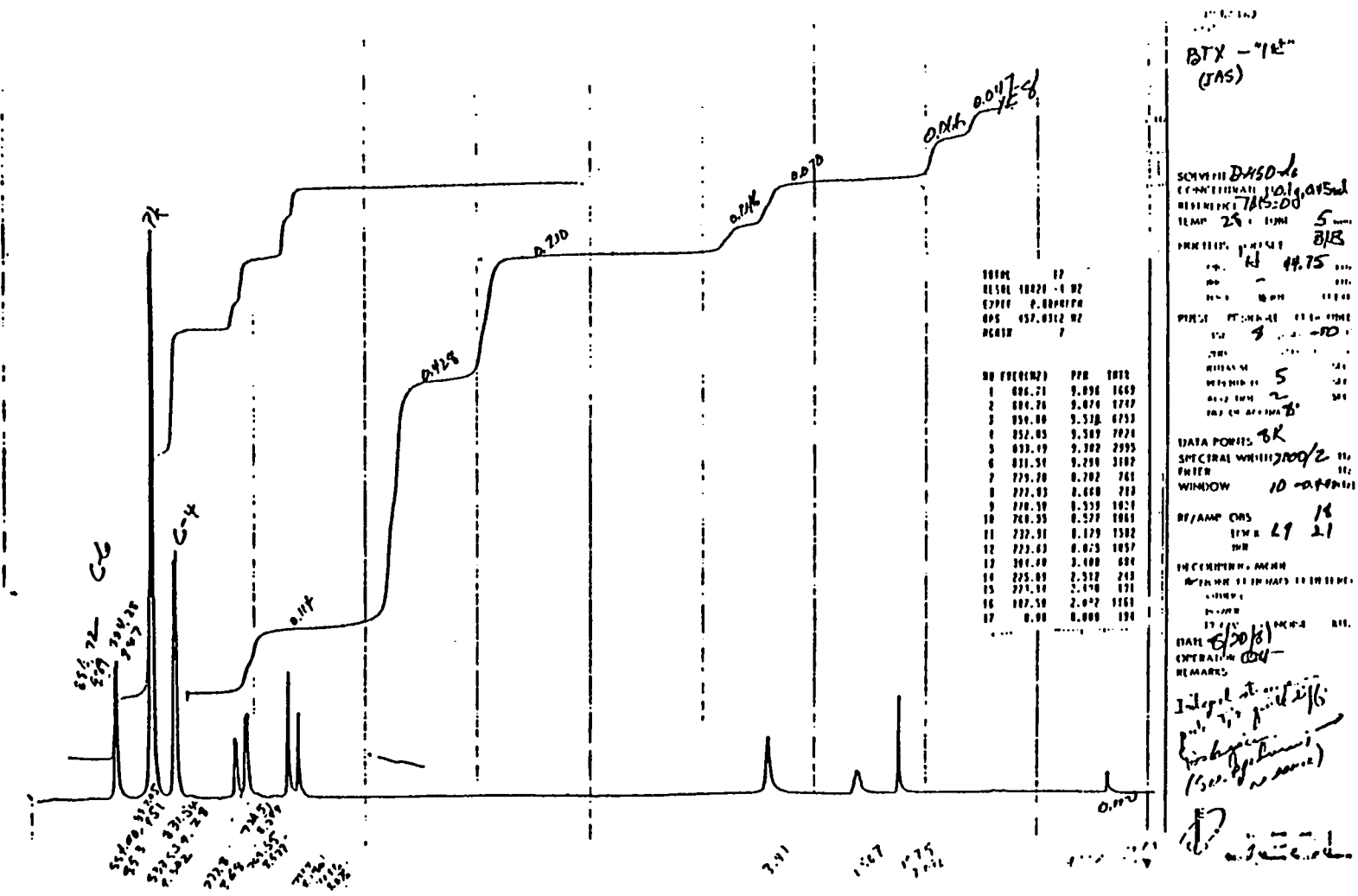

Figure C-2. NMR BTX Initial Run

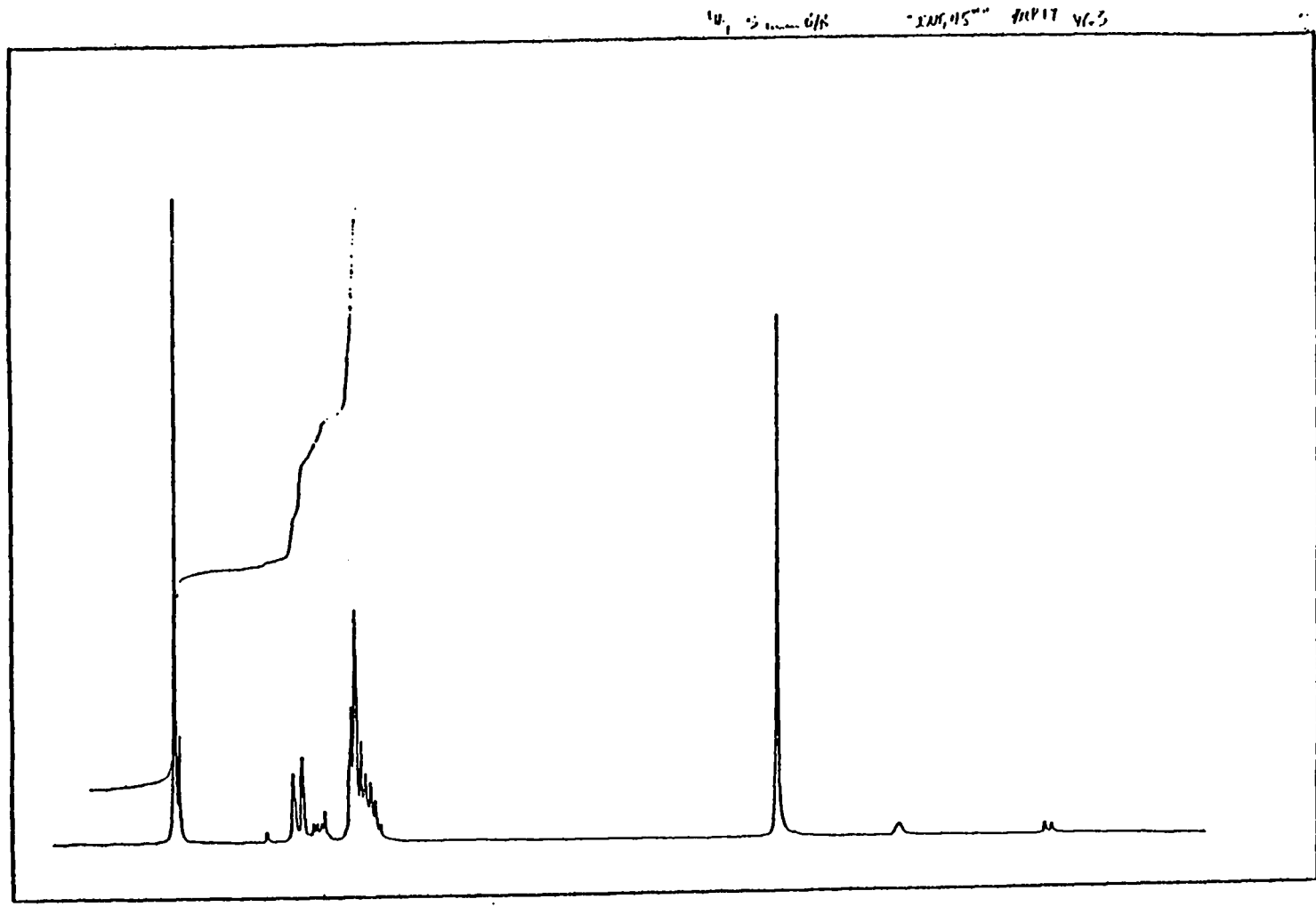

Figure C-3. NMR Intermediate 45 min.

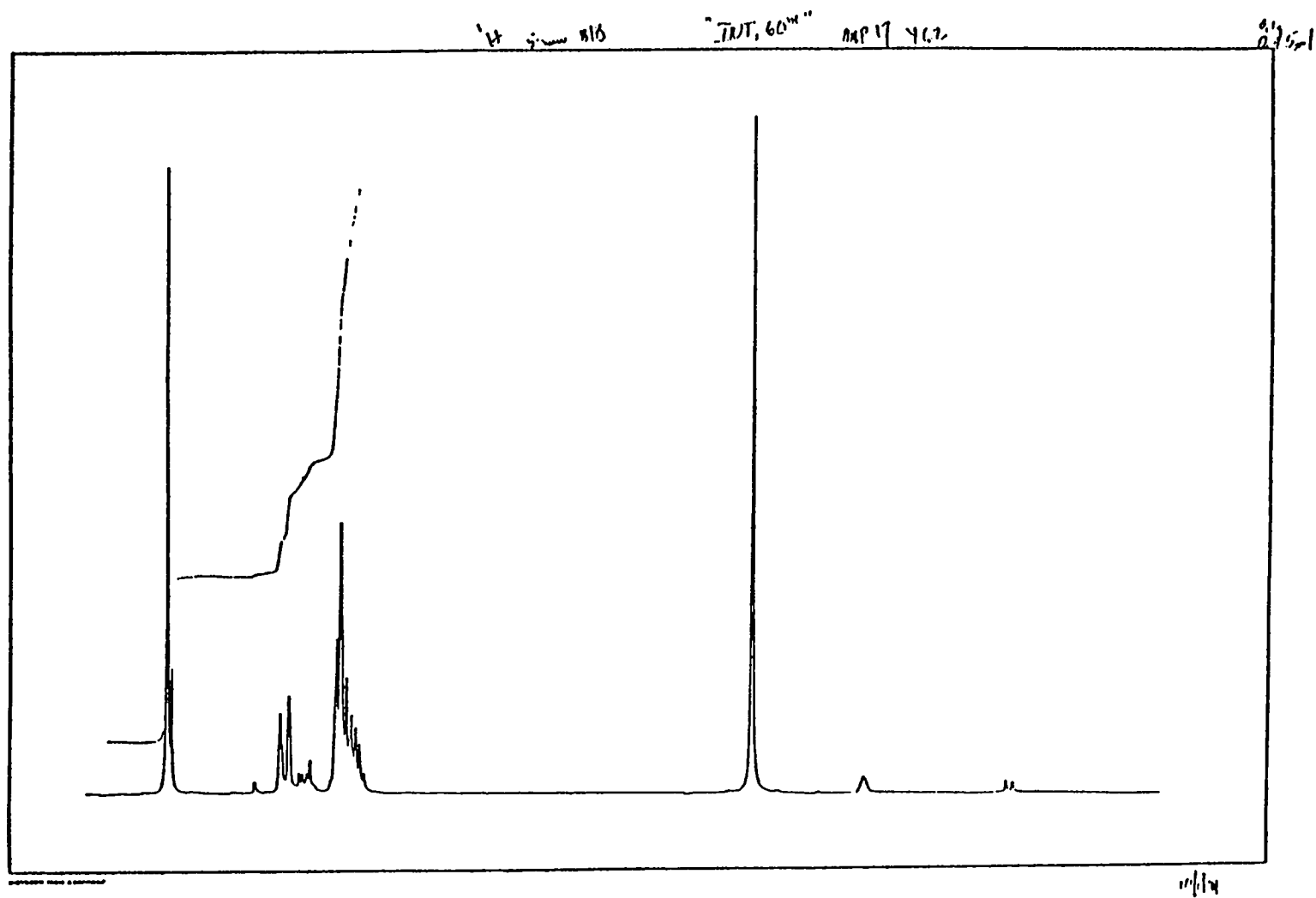
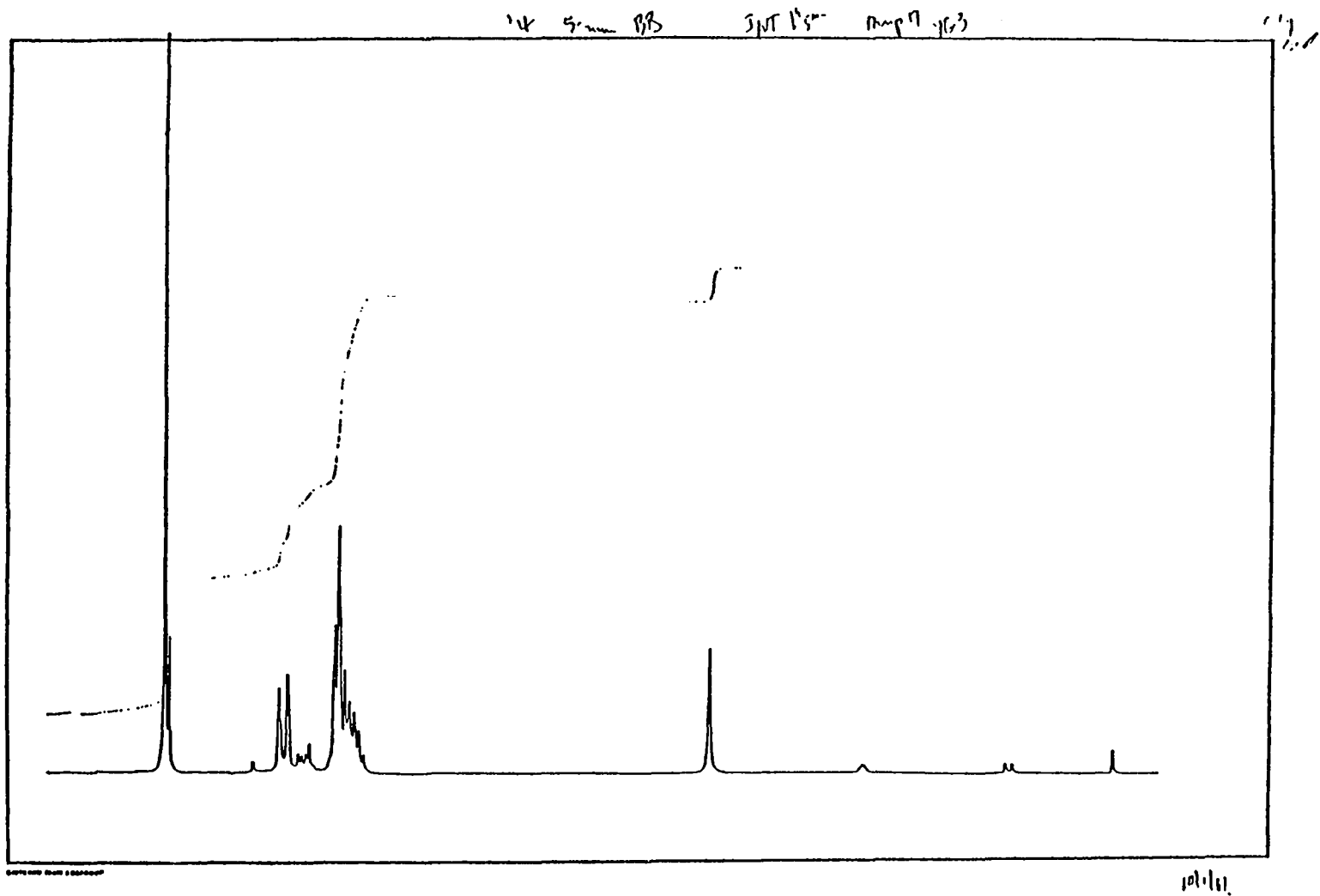

Figure C-4. NMR Intermediate 60 min.



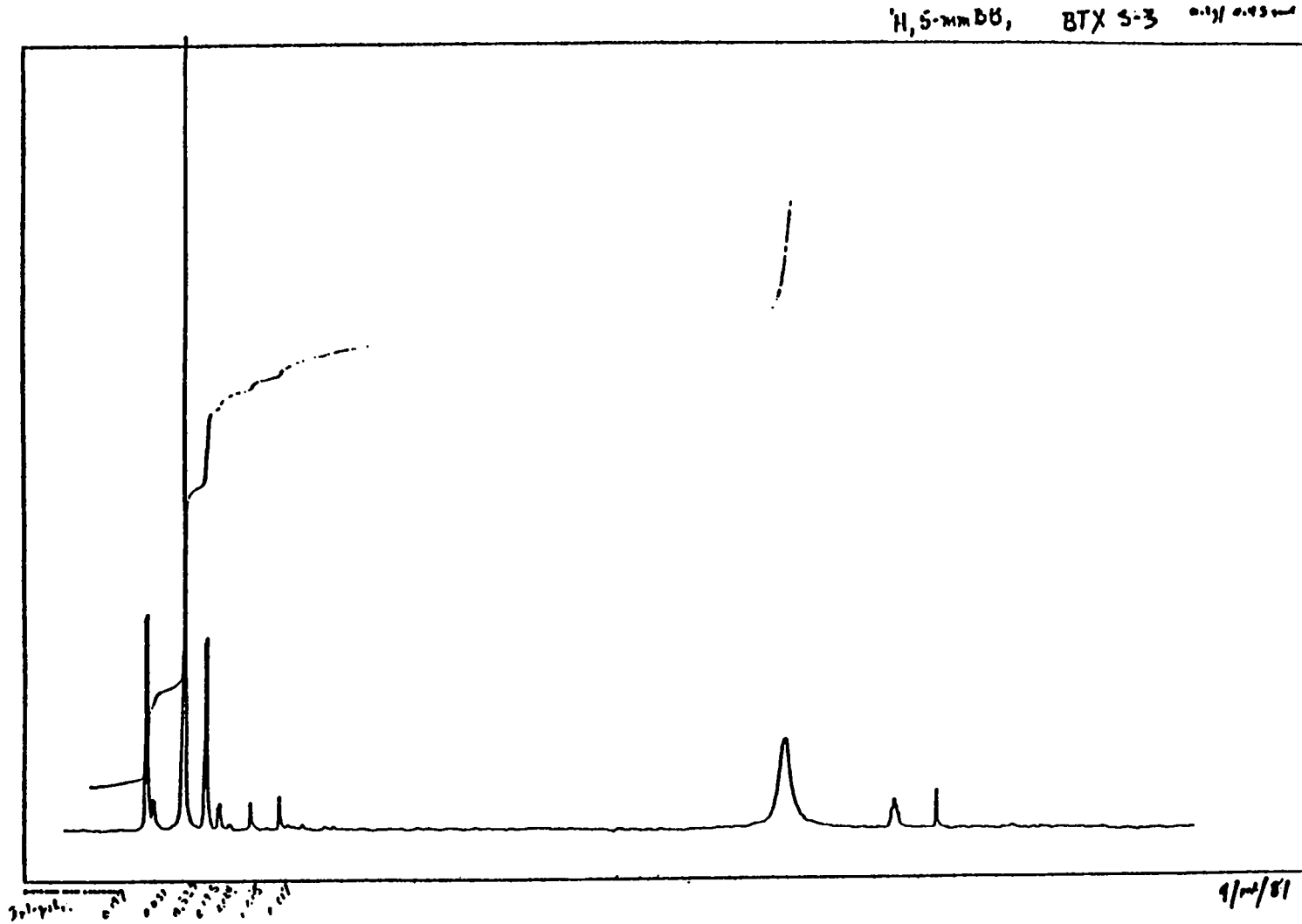

Figure C-6. NMR Analysis BTX Runs.

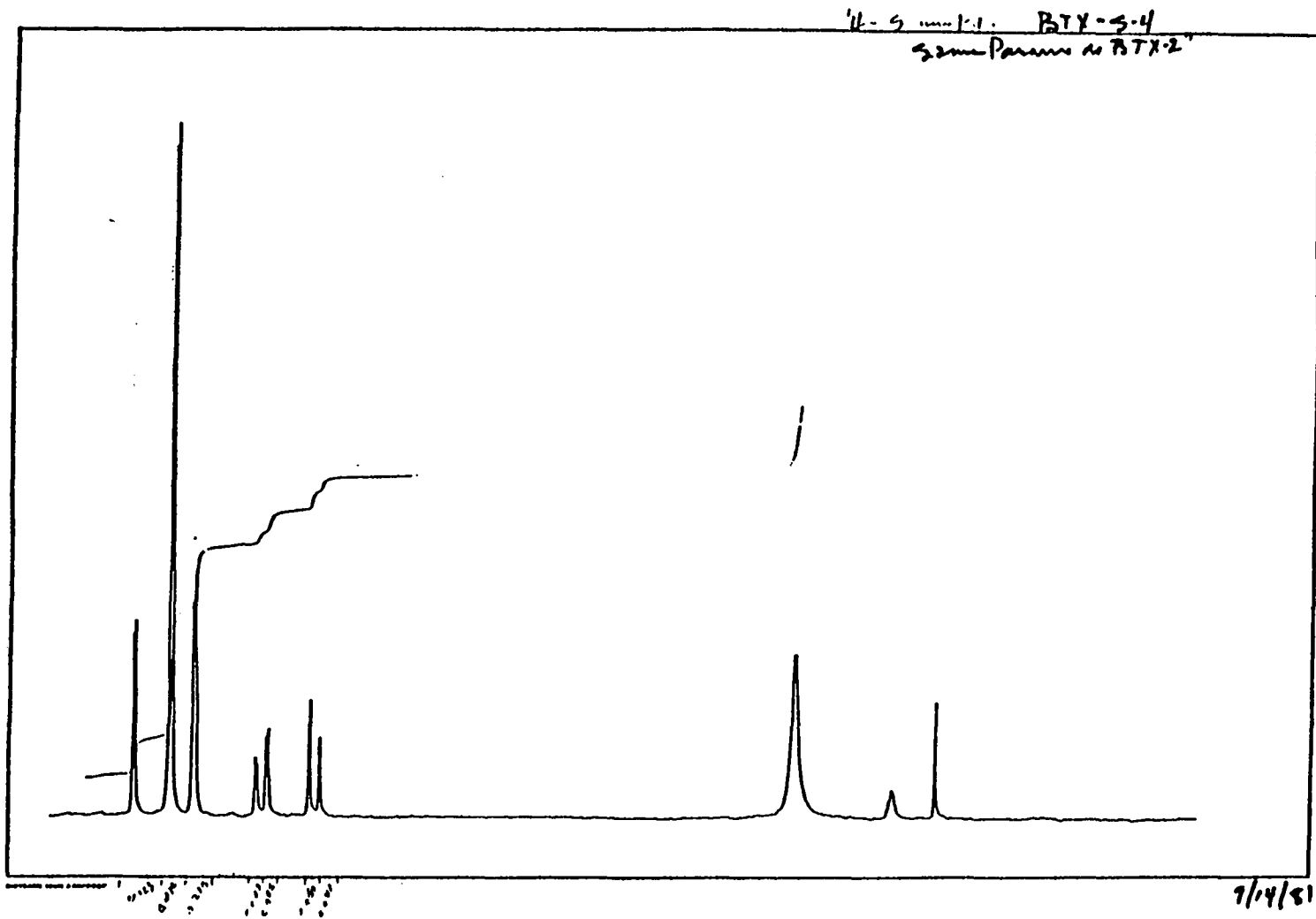

Figure C-7. NMR Analysis BTX Run 4.

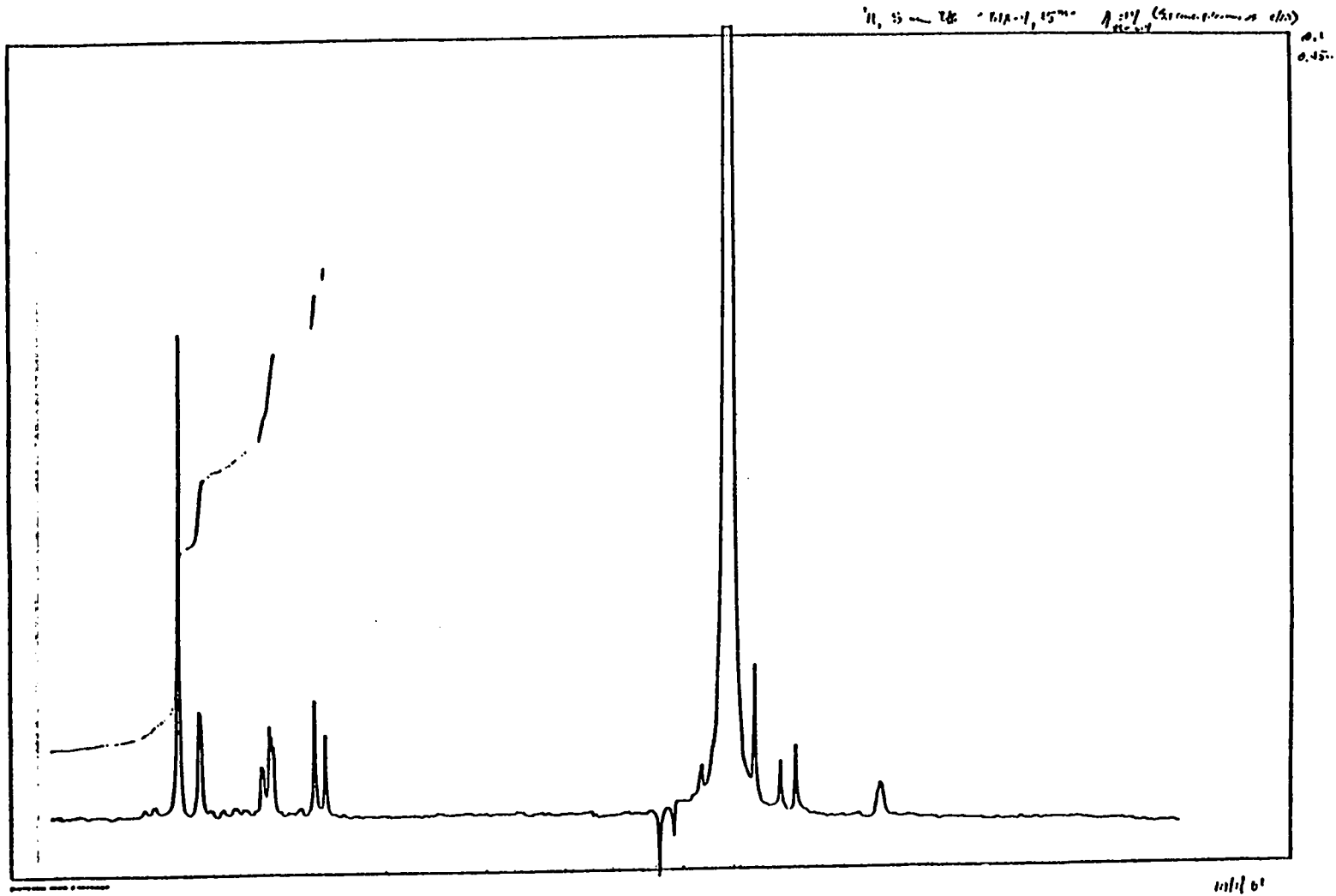

Figure C-8. NMR Analysis BTX Run 4 15 min.

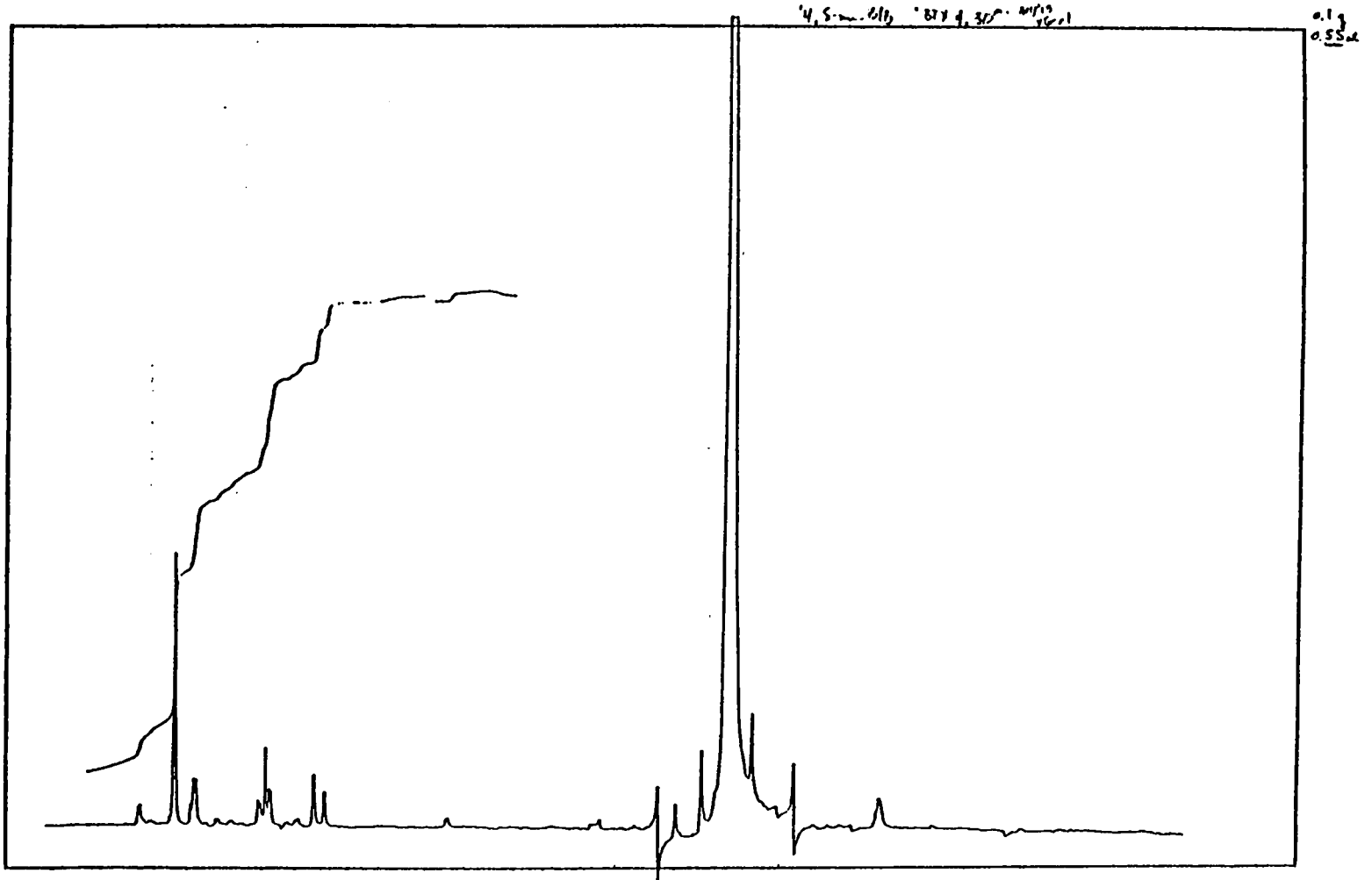

Figure C-9. NMR Analysis BTX Run 4 30 min.

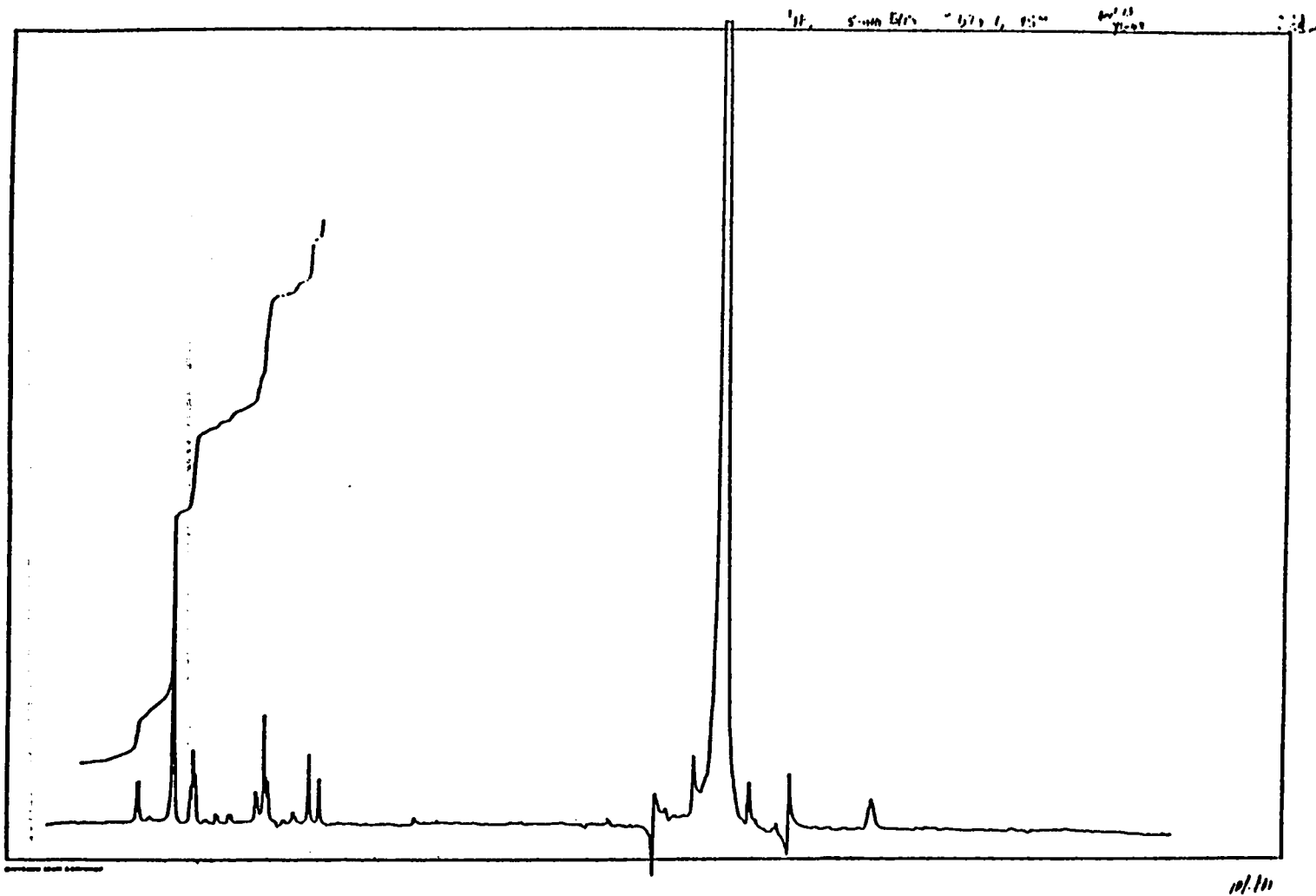
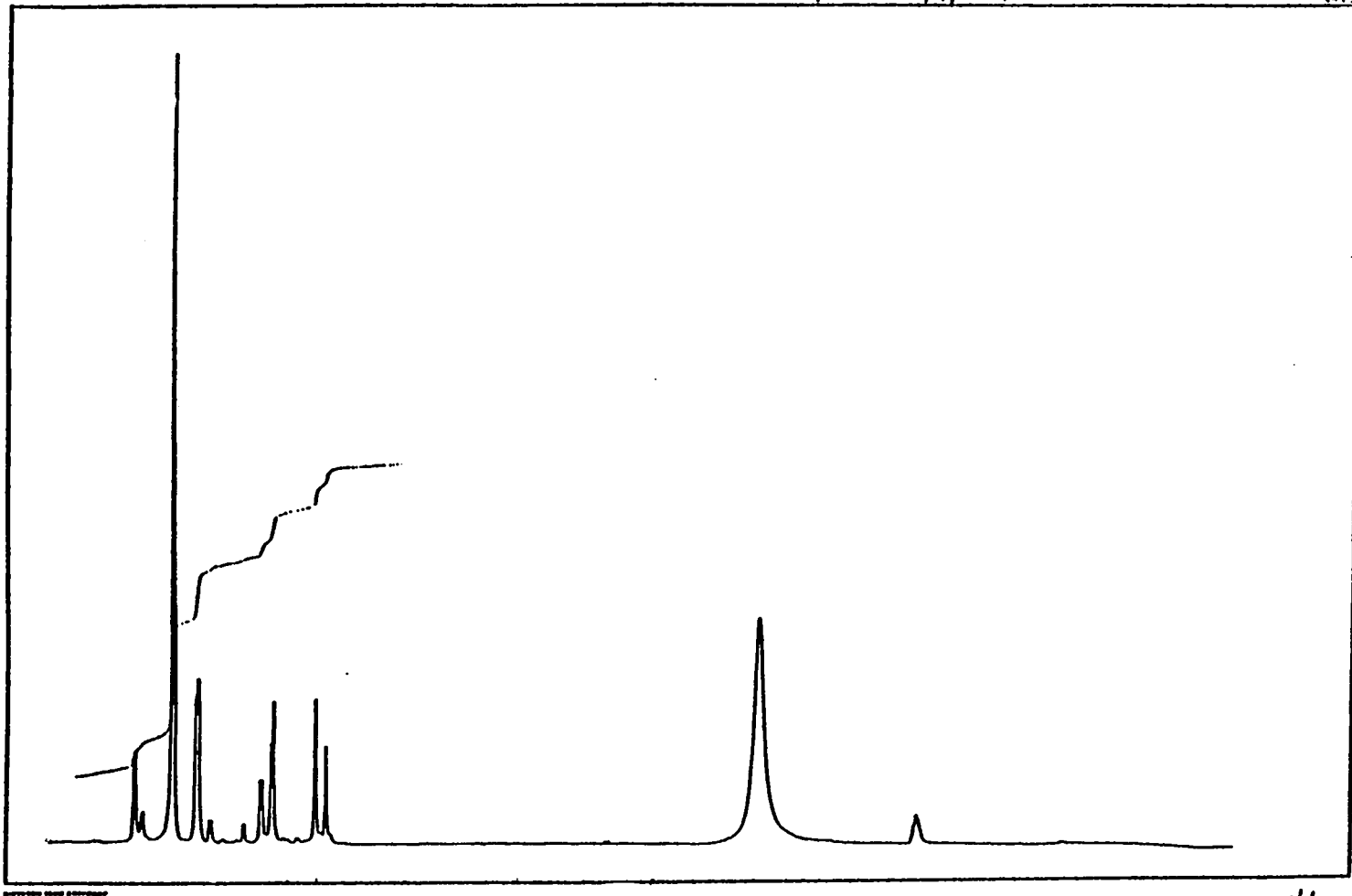

Figure C-10. NMR Analysis BTX Run 4 45 min.

U.S. 516. 877. 10¹¹ 10116

10116



10116

Figure C-11. NMR Analysis BTX Run 4 60 min.

U.S. GOVERNMENT PRINTING OFFICE: 1964-778-028 / 4037

Printed in the United States of America
Available from
National Technical Information Service
US Department of Commerce
5285 Port Royal Road
Springfield, VA 22161

Microfiche (A01)

Page Range	NTIS Price Code	Page Range	NTIS Price Code	Page Range	NTIS Price Code	Page Range	NTIS Price Code
001-025	A02	151-175	A08	301-325	A14	451-475	A20
026-050	A03	176-200	A09	326-350	A15	476-500	A21
051-075	A04	201-225	A10	351-375	A16	501-525	A22
076-100	A05	226-250	A11	376-400	A17	526-550	A23
101-125	A06	251-275	A12	401-425	A18	551-575	A24
126-150	A07	276-300	A13	426-450	A19	576-600	A25
						601-up*	A99

*Contact NTIS for a price quote.

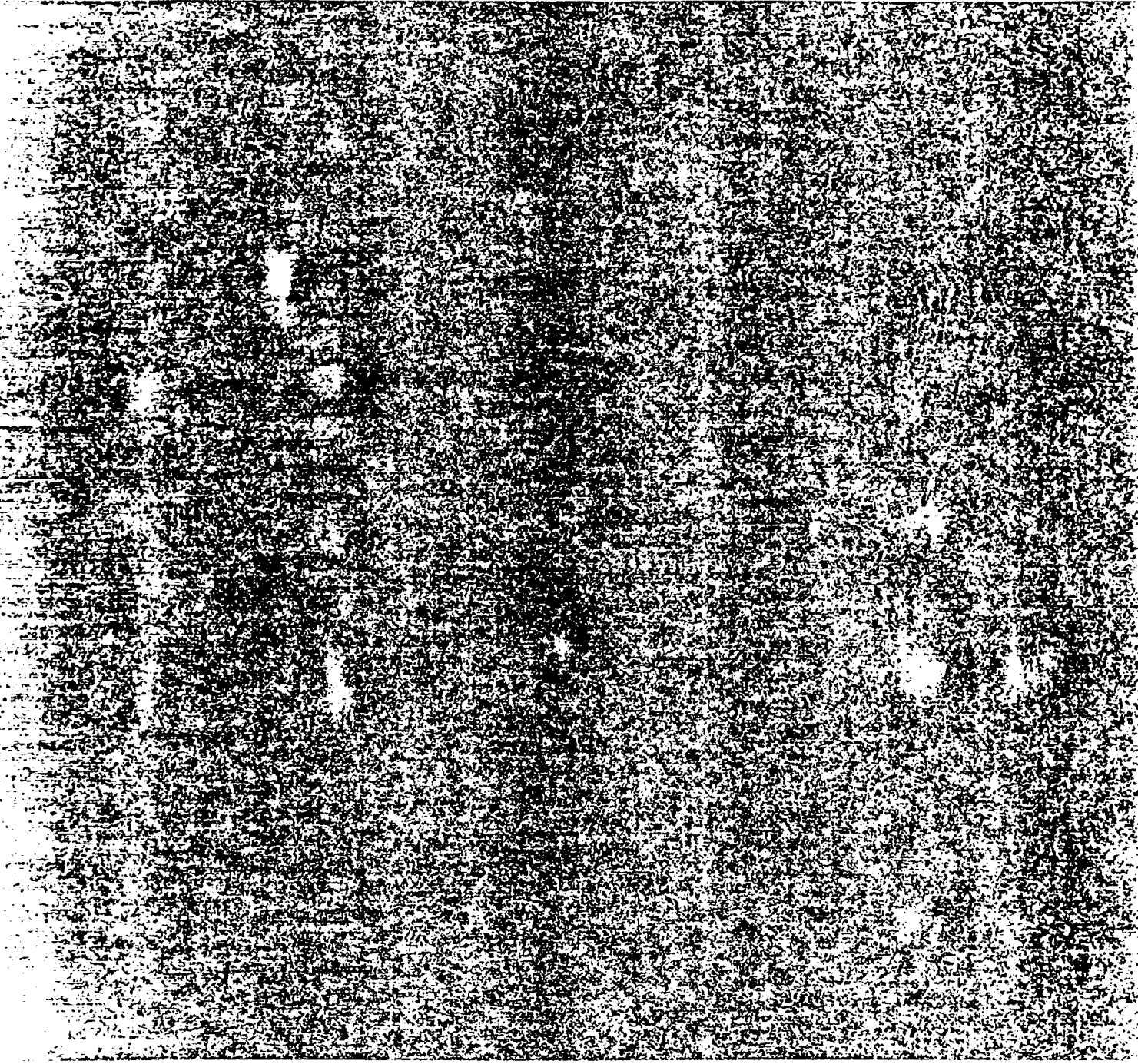

Los Alamos